

G3.5

Insert with AutoFire™



TWO DECADES
OF LEGENDARY HEAT.

 **Valor** Radiant
Gas Fireplaces

THE SCIENCE OF WARMTH™

Since 1890, we've been pioneering and perfecting radiant heat technology that generates constant, comfortable warmth within your home.

RADIANT HEAT

What's makes Valor unique? We put radiant heat technology into every fire. You can feel it.

AUTOFIRE™

Pioneered by Valor, AutoFire automatically adjusts the fire for optimum efficiency and enjoyment.

EFFICIENCY

Radiant zone heating is up to 25% more efficient than central forced air systems.

REMOTE CONTROL

Adjustable flame for constant, even warmth without having to cycle the fire on and off—or leave the sofa.

SAFETY

Our fires are put through rigorous safety testing in our in-house CSA approved lab.

REALISTIC LOGS

High definition, low mass fiber ceramic logs heat up and glow quickly, radiating warmth.

COVER:
Birch with
Reflective Glass liner
Craftsman Pewter front
with Black Backing plate

TRADITIONAL LOGS





CONVECTIVE HEAT

Secondary Heat Exchanger naturally improves convective heat—without a fan.

V-CLASS BURNER

Our precision stainless steel V-Class burner creates an enhanced flame and ember glow.

NO POWER. NO PROBLEM.

Valor fireplaces heat without electricity—even in a power failure.

CERAMIC GLASS

Durable and robust ceramic glass improves radiant performance.

SUPERIOR ALUMINIZED STEEL

Aerodynamic aluminized steel firebox handles high temperatures, delivering efficient radiant warmth.

Please Note: Printed images may vary from actual product. All product information is accurate at time of printing and is subject to change. For more information, visit valorfireplaces.com

**PROUDLY MADE
IN NORTH AMERICA**

INSERT GAS FIREPLACES

Old wood fireplaces are highly inefficient heaters. Replace yours with a gas insert for an air-sealed, energy efficient and easy-to-use source of home comfort.



1 LOGS

We design all our expertly crafted logs as realistic-looking as possible, and engineer them to harness radiant heat from the flames and glowing embers.



BIRCH **NEW**



TRADITIONAL LOGS **NEW**



DRIFTWOOD **NEW**

TRADITIONAL LOGS **NEW**
LEDGESTONE LINER **NEW**
EDGEMONT CRAFTSMAN BRONZE **NEW**
WITH BLACK BACKING PLATE



To see in person, visit your local Valor dealer; or go to valorfireplaces/g35 for photos and videos of the fuel beds.

This minimalist Pebble Beach Driftwood has an easygoing flame and beachy look.

The modern Murano's clear tumbled glass is illuminated by the fire, casting reflections on the glass base.



PEBBLE BEACH DRIFTWOOD



MURANO GLASS

TIP

Liners can appear quite different with the fire on compared to a natural light setting.



2

LINERS

Choose a firebox liner to complement the logs and front style you select as well as the surround of your current fireplace.

Please note the tint of the ceramic glass window can warm the liner colors, especially when the fire is on. If possible, visit your local Valor dealer to see a sample in person.



LEDGESTONE **NEW**



BIRCH
REFLECTIVE LINER
EDGEMONT VINTAGE IRON FRONT
BLACK BACKING PLATE

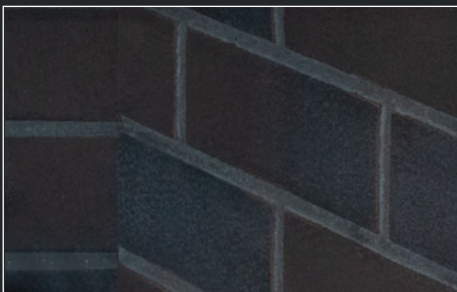

BRICK



FLUTED BLACK



REFLECTIVE GLASS



3 FRONTS

Select a front that suits your home and style. Your dealer can help you choose, if necessary, a backing plate to complement your front that fits your installation. For more images, visit valorfireplaces.com/g35

EDGEMONT FRONTS: Edgemont fronts are about 2" wide, and slightly offset from the required backing plate.



CRAFTSMAN PEWTER
NEW



CRAFTSMAN BRONZE
NEW



CRAFTSMAN BRASS
NEW



VINTAGE IRON



BRONZE



BRUSHED NICKEL



TRADITIONAL LOGS
 REFLECTIVE LINER
 EDGEMONT BRUSHED NICKEL FRONT
 BLACK BACKING PLATE (717BPB)

FLOATING FRONTS: The 4" wide floating fronts sit proud of either the wall or the two optional backing plates by 1.5".



4-SIDED BLACK



3-SIDED BRUSHED NICKEL



4-SIDED VINTAGE IRON



3-SIDED BLACK



3-SIDED BRONZE



3-SIDED VINTAGE IRON



FINISHES

You can see the craftsmanship in our fronts. Made of steel and then powder-coated, or plated with an artisan touch—both offer durable, long-lasting finishes. If possible, visit your local Valo dealer to see a finish in person.

NEW
BRUSHED BRASS:
Edgemont Craftsman

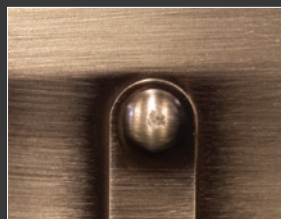

NEW
BRONZE:
Edgemont Craftsman

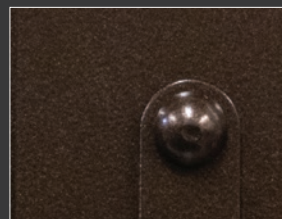

NEW
PEWTER:
Edgemont Craftsman



NEW DRIFTWOOD
FLUTED BACK LINER
3-SIDED VINTAGE IRON FLOATING FRONT



BLACK:
Floating fronts +
all backing plates

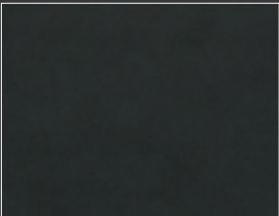

VINTAGE IRON:
Edgemont +
Floating fronts



BRONZE:
Edgemont +
Floating fronts



BRUSHED NICKEL:
Edgemont front



DIMENSIONS

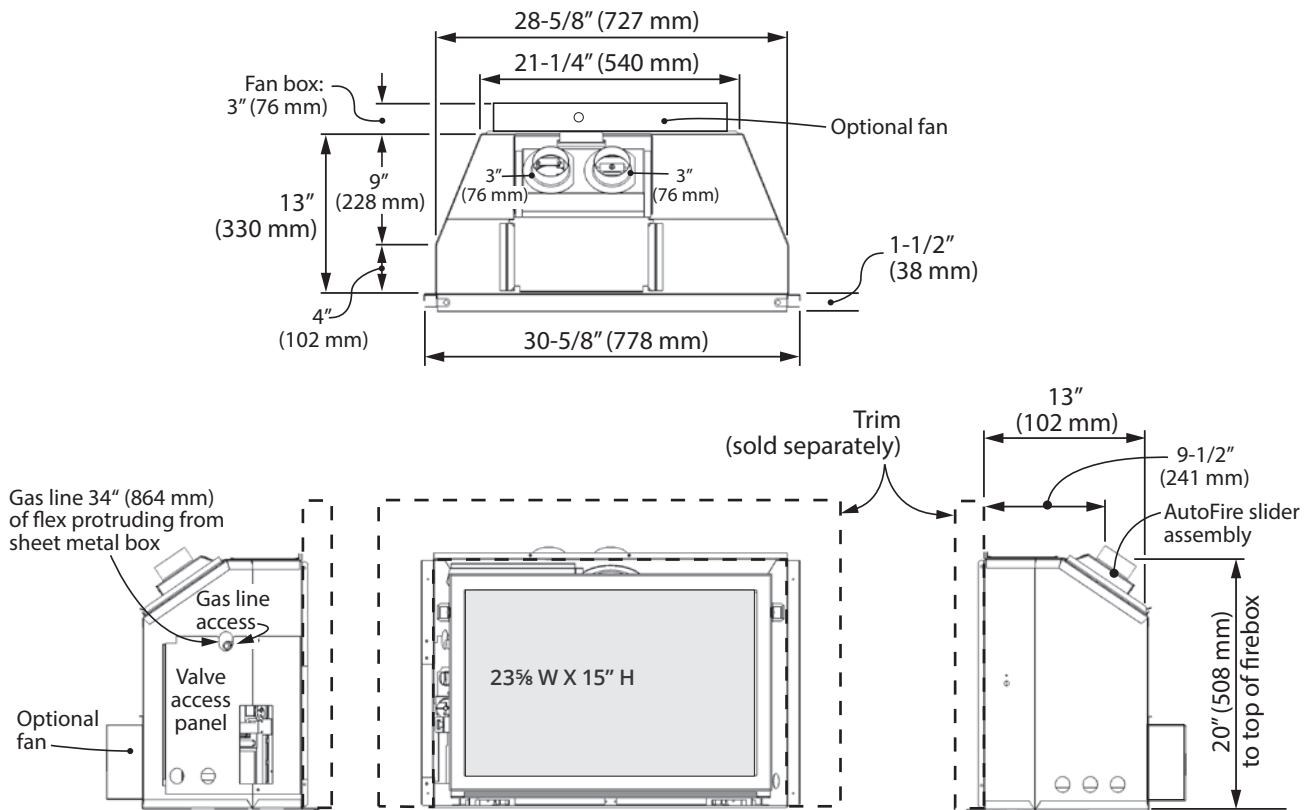

MINIMUM CAVITY DIMENSIONS

MINIMUM DIMENSION	WITH 717BPBF (FLAT PLATE)	WITH ALL OTHER BACKING PLATES
Min. depth (X)	14 1/2"	13 1/2"
Min. depth (X) with fan	17 1/2"	16 1/2"
Min. height (Y)	22 3/8"	20 1/2"
Min. width (not shown)	30 7/8"	28 7/8"

Note: Raise the appliance by 2 5/8" when using the 719BPB 4-Sided Backing Plate as the plate extends below the bottom of appliance.

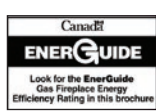
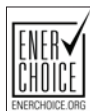
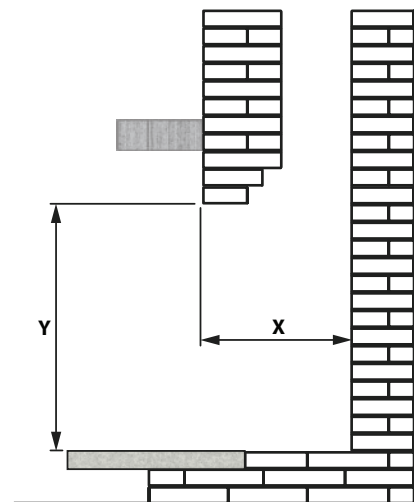

Designed and manufactured by
Miles Industries Ltd.
Copyright Miles Industries Ltd. 2020

MANTEL CLEARANCES

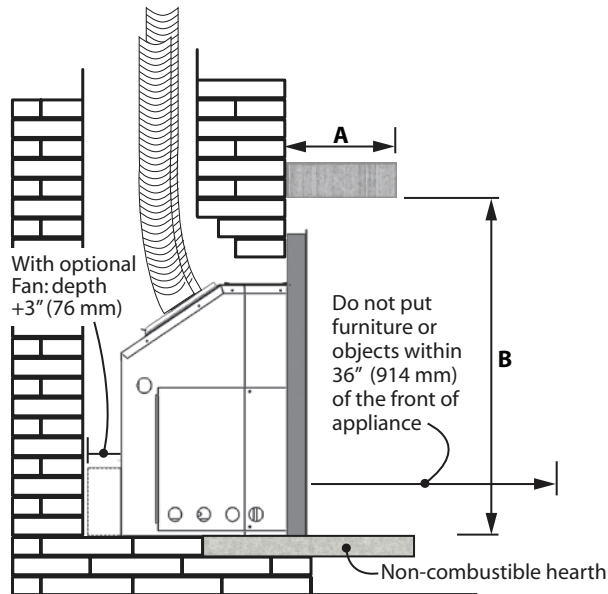

Mantel Projection A	0 - 6"	8"	10"	12"
Mantel Height B*	33"	35"	37"	39"

*Measured from underside of mantel to finished hearth or surface that unit sits on.

ALWAYS REFER TO THE MANUAL FOR COMPLETE INSTALLATION INSTRUCTIONS.

VENTING

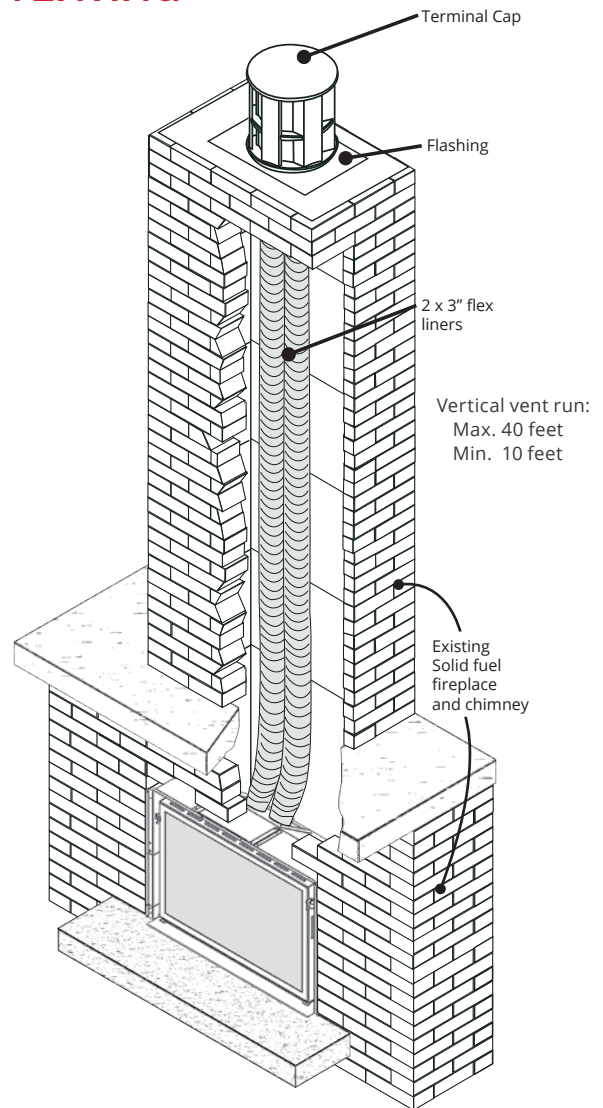

⚠ WARNING

This product can expose you to chemicals including Benzene, which is known to the State of California to cause cancer and birth defects or other reproductive harm.
For more information go to www.P65Warnings.ca.gov

Note: Natural gas, in its original state, contains Benzene.

BACKING PLATES

EDGEMONT BACKING PLATES

All Edgemont, Hammered and Craftsman fronts require Edgemont backing plates, available in 3 and 4-sided styles and different thicknesses.

The fronts are slightly offset from the backing plate. See below.

NEW



Backing plate:
1/8" thick.

OTHER BACKING PLATES

The flat backing plates below pair with the 3" Floating fronts. Available in a small and large size, these backing plates may also be used with Edgemont backing plates to cover a larger opening.

The Floating fronts sit proud of the backing plates by 1.5".

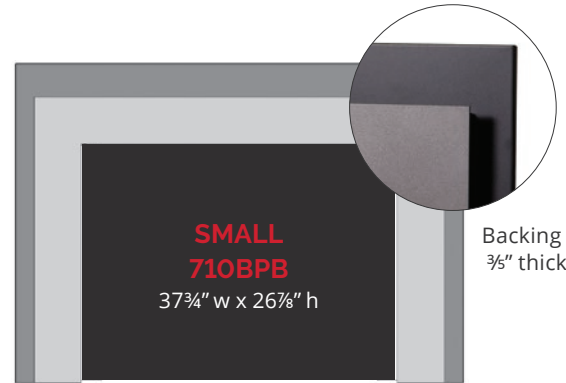

Backing plate:
3/8" thick.

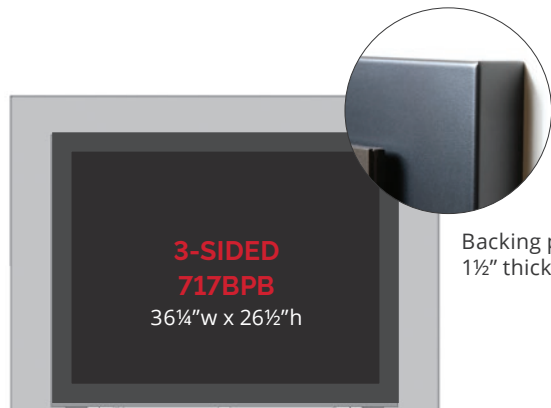

Backing plate:
1 1/2" thick

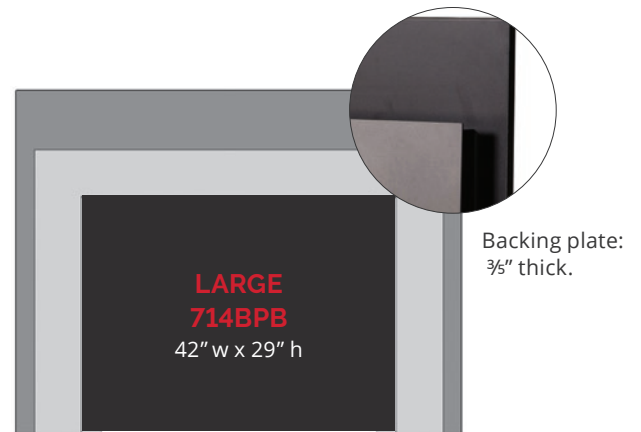

Backing plate:
3/8" thick.

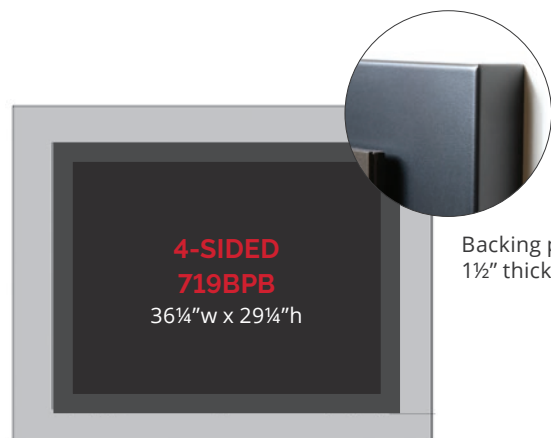

Backing plate:
1 1/2" thick

OPTIONS

1 FUEL BED

Birch NEW	700BLK
Traditional logs NEW	700LSK
Driftwood NEW	700DWK
Pebble Beach Driftwood	700XDWK
Murano Glass	700XDGM

DIRECT VENT FIREPLACES

Stainless Steel Burner: Natural Gas or Propane	700MN 700MP
Ceramic Burner: Natural Gas or Propane	700XN 700XP

2 LINER

Ledgestone NEW	705LSLV3
Fluted Black	707FBL
Reflective Glass	706RGL
Valor Red Brick	708VRL

3 CHOOSE A FRONT:

EDGEMONT

Brushed Nickel	721EDN
Vintage Iron	721EDV
Bronze	721EDZ
Craftsman Champagne Brass NEW	716ECCB
Craftsman Pewter NEW	716ECPW
Craftsman Bronze NEW	716ECBR

FLOATING

Black		709FTB
Brushed Nickel	3-SIDED	709FTP
Vintage Iron	33¾" w x 23½" h*	709FTV
Bronze		709FTZ
Black	4-SIDED	713FFB
Vintage Iron	33¾" w x 27½" h*	713FFV

* Coverage dimensions. Overall front dimensions are slightly large than coverage area, due to a return. Use coverage dimensions when installing.

OPTIONAL RISER

Black, small	40" w x 2½" h	725RTB
Black, large	46¼" w x 2½" h	793RTB
Vintage Iron, large	46¼" w x 2½" h	793RTV

4 CHOOSE A BACKING PLATE:

REQUIRED EDGEMONT BACKING PLATE

+	3-SIDED BACKING PLATE 717BPB	or	NEW 3-SIDED FLAT BACKING PLATE 717BPBF	or	4-SIDED BACKING PLATE 719BPB
----------	--	-----------	--	-----------	--

OPTIONAL FLOATING BACKING PLATE

+	3-SIDED, SMALL 710BPB	or	3-SIDED, LARGE 714BPB
----------	---------------------------------	-----------	---------------------------------

You can also use these backing plates with backing plate 717BPB to cover larger fireplace openings.

FUEL BTU/HR

FUEL	MAX. INPUT	MIN. INPUT	MAX. OUT W/O FAN*	ENERGUIDE*
700MN	26,000	13,000	20,933	70.00%
700MP	26,000	11,000	20,933	70.00%
700XN/XP	24,000	13,000	17,825	70.40%

ABOUT OUR EFFICIENCY RATINGS

While the North American fireplace industry is largely self-regulated, at Valor we use recognized Canadian and US government testing methods to determine our energy efficiencies, and ensure our products perform in your home as rated. To find out more, visit valorfireplaces.com/efficiency

* EnerGuide Ratings and Outputs have been determined without a fan/blower, using the CSA P4.1-15 test method. Certified to ANSI Z21.88/ CSA 2.33 Vented Gas Fireplace Heater American National Standard. CGA — 2.17-91 Gas Fired Appliances for use at High Altitudes.

PEBBLE BEACH DRIFTWOOD
FLUTED BLACK LINER
EDGEMONT VINTAGE IRON FRONT
BLACK BACKING PLATE



BRG3520E JULY

valorfireplaces.com

valor
Radiant
Gas Fireplaces