

wood  
stoves, fireplaces & inserts

# why choose Regency?

## Clean Burning Heating Solutions

In 1979, I founded Regency Fireplace Products with a mission to produce the finest fireplace products available anywhere. As a result, Regency has been honored with awards for exceptional aesthetics and performance. It is known as the premium brand in the industry.

There are so many reasons to choose a Regency, I would like to share a few with you.

## Save money... Zone heat

Never before have home heating costs been higher. Turn your furnace way down and zone heat with beautiful, renewable wood in the rooms you spend time in. Not only can you cut your fuel bills in half but you will be able to enjoy the timeless joy of a wood fire. The glowing embers, the snap of wood as it catches fire, the casual curl of yellow flames, there is nothing like a wood fire.

## Environmentally Friendly

All Regency Wood Stoves, Fireplaces and Inserts have been certified by the Environmental Protection Agency (EPA). Regency engineers have carefully designed the firebox to create airflow around

the wood so that it burns completely, resulting in very little ash and almost no polluting smoke into our environment. Burning wood is also carbon neutral.

## Regency Quality

The Regency name means quality in every way. I am supported by an exceptional team, state of the art research and a world class manufacturing facility. We have carefully selected a dealer network that is committed to your satisfaction.

## Lifetime Warranty

I am so confident in the quality workmanship, the finest materials, and durable heavy-duty construction invested in each and every product, that I offer a Limited Lifetime Warranty. We know that you will be as proud of your Regency Wood Stove, Fireplace or Insert as we are – I guarantee it.



Robert Little  
Founder & CEO



DoctorFlue.com

## index

Regency Alterra Wood Stoves CS1200, CS2400	6
Regency Classic Wood Stoves F1100, F2400, F3100, S2400	8
Regency Alterra Wood Inserts CI1200, CI1250	10
Regency Classic Wood Inserts I1200, Hearth Heater I2400 & I3100	12 14
Regency Wood Fireplaces R90 & EX90	16
Design Choices	18
Technical Specs	20







renewable

affordable

beautiful



# burning wood - a green choice

## Wood is affordable

Reduce your dependence on high priced, non-renewable home heating fuels by burning wood. Turn your furnace down and enjoy comforting warmth in your main living area with a Regency wood product. Whether you buy your wood or collect it yourself, you will notice the savings within its first year.

## Renewable Resource

Wood is a renewable natural resource - well-managed forests are a renewable, sustainable source of energy that helps us reduce greenhouse gas emissions and be less dependent on oil & gas.

## Wood is Carbon Neutral

As trees grow they absorb carbon dioxide from the atmosphere. When trees die and are left to decompose in the forest or burn in forest fires the carbon stored in the trees is released in the atmosphere as carbon dioxide.

Burning firewood produces the same amount of carbon dioxide as it has absorbed during its life cycle - making wood burning carbon neutral.

## EPA certified

All Regency Wood Stoves, Fireplaces and Inserts have been tested and certified to the strictest clean air standards as set by the Environmental Protection Agency. In addition, all Regency wood products exceed efficiency standards confirming their approval for the US biomass tax credit for up to \$300 (expires Dec. 31, 2011).

## One Regency = One Tree

At Regency, we are committed to protecting our environment. For every Regency sold, we will plant a tree. Working with American Forests, the trees planted across North America will offset carbon emissions and take one more step to restore nature's balance.

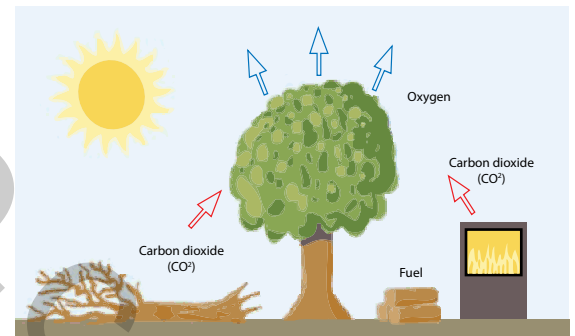



CS2400 shown with stainless steel side panels and black floor pad.

## Alterra™ Wood Stoves

CS1200 & CS2400



### Modern Styling – Traditional high efficiency heat

The striking, contemporary design of Regency's Alterra wood stove puts the focus on the brilliant glowing fire. With an impressive 20% greater viewing area than traditional wood stoves, and a convenient firewood storage area at the base, the Alterra is perfectly proportioned for visual pleasure and easy loading. The unique modern styling is complemented by the Regency tradition of reliability and high efficiency.

#### Standard Features

- Metallic black cast iron door
- Reversible cast iron door with removable handle
- EPA Certified
- Mobile home and alcove approved
- Closest clearances in the industry
- Single rod draft control
- Brick-lined firebox
- Airwash system
- Built-in top louver airmate

#### Optional Features

- Side panels in black, stainless steel, red (CS1200 only) and blue (CS1200 only)
- Ash drawer
- 2-speed blower
- Outside air kit
- Metallic black floor pad





CS1200 shown with red side panels and black floor pad.

Available in two sizes, both the CS1200 and larger CS2400 deliver incredible high efficiency heat in two different footprints. All Regency wood stoves produce more heat using less wood and a longer burn. Enjoy clean burning wood heat over night all winter long.

Specifications	CS1200	CS2400
Maximum BTU*	55,000	75,000
Typical Sq. Ft. Heated	600-1200	1000-2200
Efficiency	77.7%	77%
Maximum Log Size	18"	18"
Burn Time (Typical)*	up to 8 hrs	up to 8 hrs
Emissions (grams/hr)	3.0g	3.4g
Firebox Size	1.4 cu. ft.	2.3 cu. ft.
Flue Size	6"	6"

\* Length of burn time and BTU range depend on type of wood, moisture content, climate conditions and installation.



CS1200 shown with blue side panels



CS1200 shown with black side panels



CS1200 shown with red side panels





F2400 shown with legs and gold accent door.

## Classic Wood Stoves

F1100, F2400, F3100, S2400



### Classic design in three sizes

The timeless styling of the Classic Wood Stove comes in three sizes producing from 55,000 to 80,000 BTU of toasty warmth for a single living area or an entire home. Up to 77% efficiency means any room can be heated quickly. It also means your wood stove burns cleanly meeting the strictest air quality standards set by DEQ Washington Phase II Clean Air Standard of 4.5 grams/hr. or less.

#### Standard Features

- EPA Certified
- Mobile home and alcove approved
- Closest clearances in the industry
- Single rod draft control
- Brick-lined firebox
- Airwash system
- Rear heat deflector

#### Optional Features

- Cast iron door in gold, black\*\*, gold accent or nickel accent
- Cast iron legs in gold, black or brushed nickel
- Pedestal base
- Bottom heat shield (when using legs)
- Ash drawer
- 2-speed blower
- Convector airmate
- Outside air kit
- Screen door





S2400 shown with pedestal and gold plated door.

The special design of the Step Top Classic makes it possible for it to be placed close to a corner of the wall. This makes it ideal for a medium sized room or for installation in tight alcoves. All Regency wood products offer a optional two speed blower to help deliver high efficiency heat to the far reaches of your home.



F2400 shown with pedestal



F2400 shown with pedestal and nickel accent door



S2400 shown with pedestal

Specifications	F1100	F2400	S2400	F3100
Maximum BTU*	55,000	75,000	75,000	80,000
Typical Sq. Ft. Heated	600-1200	1000-2200	1000-2200	2000-3500
Efficiency	77.7%	77.0%	77.0%	75.4%
Maximum Log Size	18"	18"	18"	21"
Burn Time (Typical)*	up to 8 hrs	up to 8 hrs	up to 8 hrs	up to 10 hrs
Emissions (grams/hr)	3.0g	3.4g	3.4g	4.2g
Firebox Size	1.4 cu. ft.	2.3 cu. ft.	2.3 cu. ft.	2.9 cu. ft.
Flue Size	6"	6"	6"	6"

\* Length of burn time and BTU range depend on type of wood, moisture content, climate conditions and installation.

\*\* Black doors come with nickel handles & nickel hinge caps





Alterra CI1250 wood insert

## Alterra™ Wood Inserts

CI1250 & CI1200



### Transform your fireplace

The Regency Alterra Wood Insert Collection is the next generation in contemporary fireplace design. It combines the unparalleled tradition of high quality, industry leading engineering along with a sleek, modern design. The Alterra features a flush door and surround that transforms your inefficient fireplace opening into a style savvy, efficient heater.

#### Standard Features

- Metallic black cast iron faceplate
- Reversible cast iron door with removable handle
- EPA Certified
- Single rod draft control
- Airwash system
- Brick-lined firebox
- 2-speed blower (CI1250 only)

#### Optional Features

- Regular or custom backing plates
- Regency stainless steel flex liner kit
- Standard or 4-1/2" offset flue adaptor (patented)





Alterra C1200 wood insert

The Alterra is also available without the blower providing you with installation flexibility. Both models have been specially designed to fit into most masonry or factory built open fireplaces.

Specifications	C1200	C1250
Maximum BTU*	55,000	55,000
Typical Sq. Ft. Heated	600-1000	600-1000
Efficiency	77.7%	77.7%
Maximum Log Size	18"	18"
Burn Time (Typical)*	up to 8 hrs.	up to 8 hrs.
Emissions (grams/hr)	3.0g	3.0g
Firebox Size	1.4 cu. ft.	1.4 cu. ft.
Flue Size	6"	6"

Minimum fireplace opening		
Width	25"	25"
Height	19-5/8"	23"
Depth (with standard adaptor)	15-1/16"	15-1/16"
Depth (with offset adaptor)	17-11/16"	17-11/16"

\* Length of burn time and BTU range depend on type of wood, moisture content, climate conditions and installation.



C1200



C1250







Regency I1200 with nickel accent door, regular faceplate and blower.

## Classic Wood Inserts

I1200 & H2100 Hearth Heater

### Incredible Heat for any sized room

The Regency I1200 classic wood insert is ideal for that charming fireplace that isn't quite big enough for standard inserts, or for that space in your home that invites a more compact style of fireplace. Yet this small insert delivers a generous 55,000 BTU's of heat and offers a dramatic view through the large glass door.

#### Standard Features

- EPA Certified
- Single rod draft control
- Airwash system
- Brick-lined firebox
- Convector airmate (built-in H2100 only)

#### Optional Features

- Cast iron door in gold, black\*\*, gold accent or nickel accent
- Regular or oversize faceplate (black trim included)
- 2-speed blower
- Screen door
- Regency stainless steel flex liner kit
- Bottom 1 piece faceplate & fan support (I1200 only)
- Standard or 4-1/2" offset flue adaptor (patented - I1200 only)
- Cast iron legs in gold, black or brushed nickel (H2100 only - see diagram on p.22)





Hearth Heater H2100, with black door, regular faceplate and two speed blower.

### Cooktop Convenience

The Hearth Heater combines the best qualities of the Classic Stove and Insert series. It eliminates the cold draft of an open fireplace and because it sits out on the hearth, gives you both convective and radiant heat. Like all Regency products, the Hearth Heater operates during power outages, providing a convenient cooktop surface as well.

Specifications	I1200	H2100
Maximum BTU*	55,000	70,000
Typical Sq. Ft. Heated	600-1000	800-1500
Optimum Efficiency	77.7%	84.9%
Maximum Log Size	18"	18"
Burn Time (Typical)*	up to 8 hrs.	up to 8 hrs
Emissions (grams/hr)	3.0g	3.5g
Firebox Size	1.4 cu. ft.	1.6 cu. ft.
Flue Size	6"	6"

Minimum Fireplace Opening		
Width	23"	8"
Height	19"	20"
Depth (with standard adaptor)	13-3/4"	-
Depth (with offset adaptor)	17-11/16"	-

\* Length of burn time and BTU range depend on type of wood, moisture content, climate conditions and installation.

\*\* Black doors come with nickel handles & nickel hinge caps



I1200 shown with gold plated door



H2100 shown with nickel accent door







Regency I2400 with nickel accent door, nickel convection grills, regular faceplate and blower.

## Classic Wood Inserts

I2400 & I3100



### Zone Heat for Lower Heating Bills

Your open masonry fireplace can allow as much as 90% of your fire's heat to escape out the chimney. By adding a Regency Classic Fireplace Insert, you will keep the heat in your home. Regency Inserts are ready to install and fit easily into your existing fireplace. Increase the value of your home and decrease your monthly heating bill.

#### Standard Features

- EPA Certified
- Single rod draft control
- Airwash system
- Brick-lined fire box
- Black convection grills
- Mobile home approved (I2400 only)

#### Optional Features

- Cast iron door in gold, black\*\*, gold accent or nickel accent
- Gold or nickel convection grills
- Regular or oversize faceplate (black trim included)
- Screen door
- Regency stainless steel flex liner kit
- 2-speed blower





Regency I3100 with regular faceplate and blower.

High efficiency heat with style. Regency's wood inserts are available in 2 sizes generating up to 80,000 BTU's of heat output to heat up to 3,000 square feet with burn times of up to 10 hours. All Regency wood inserts boast an airwash system to keep the glass door cleaner longer for a better view of the fire.

Specifications	I2400	I3100
Maximum BTU*	75,000	80,000
Typical Sq. Ft. Heated	1000-2000	1800-3000
Optimum Efficiency	77.0%	75.4%
Maximum Log Size	18"	21"
Burn Time (Typical)*	up to 8 hrs	up to 10 hrs
Emissions (grams/hr)	3.4g	4.2g
Firebox Size	2.3 cu. ft.	2.9 cu. ft.
Flue Size	6"	6"

Minimum Fireplace Opening		
Width	25"	28"
Height	21-1/2"	25"
Depth (with standard adaptor)	17"	17"

\* Length of burn time and BTU range depend on type of wood, moisture content, climate conditions and installation.

\*\* Black doors come with nickel handles & nickel hinge caps



I2400 shown with black door



I2400 shown with nickel accent door







R90 featuring black louvers.

## Wood Fireplaces

R90 & EX90

### A furnace with a view

Regency's high efficiency fireplaces put a designer face on a hard working heater. Just load up your Regency and tuck in for a cozy night's sleep. Delivering up to 70,000 BTU of high efficiency heat, your Regency will burn for up to 8 hours while you rest.

#### Standard Features

- EPA Certified
- Single rod draft control
- Airwash system
- Black cast iron double doors
- Ceramic safety glass
- Brick-lined firebox
- Andirons
- Outside air kit

#### Optional Features

- Black/gold, black/brushed steel or black louvers (R90)
- Excalibur arch front in black (EX90)
- Blower
- Ash drawer
- Finishing trim (R90)
- Gravity air kit
- Masonry retainer kit (R90)
- 8" - 7" flue adaptor (Canada only)
- 8" Air cooled chimney adaptors (US only)
- HeatWave™ kit (Canada only)
- Screen door







EX90 shown with Excalibur front in black and nickel accents.

### Tasteful arched styling

Offering timeless appeal, the Excalibur fireplace is defined by the large arched viewing area that frames a captivating wood fire. The simple and reliable all-in-one draft control rod allows you to choose a slow burning fire with less heat or a robust, crackling fire to take the chill off any room.

Specifications	R90	EX90
Maximum BTU*	70,000	70,000
Typical Sq. Ft. Heated	1,000-2,200	1,000-2,200
Efficiency	77.4%	77.4%
Maximum Log Size	20"	20"
Burn Time (Typical)*	up to 8 hrs.	up to 8 hrs.
Emissions (grams/hr)	3.72g	3.72g
Firebox Size	2.5 cu. ft.	2.5 cu. ft.
Flue Size	8"	8"

\* Length of burn time and BTU range depend on type of wood, moisture content, climate conditions and installation.



R90 shown with no top louvers  
(gravity air kit installed)



R90 shown with steel louvers





# Inside your Regency Wood Stove

## Non-catalytic Technology

Regency uses non-catalytic technology which means that the airflow in the firebox is directed in such a way that smoke is reburned. This creates greater efficiency, a spectacular fire and results in cleaner emissions.

By combining non-catalytic technology with durable construction, Regency builds wood fireplaces that are guaranteed to last. These stove and insert diagrams illustrate the airflow and durable components that make Regency your heating solution.

## Limited Lifetime Warranty

All Regency products are warranted for a lifetime of great looks, ease of use and superb performance. Ask your Regency dealer for details.



**Convactor Airmate**  
Directs convection heat into your room. Allows closer clearances.

**Heat Reflective Baffle**  
Designed to reflect heat back into the firebox to enhance reburn. Improves temperature distribution and efficiency of the firebox.

**Firebox**  
Airtight and lined with firebrick to ensure wood is burned completely to deliver clean efficient heat.

**Side Shields**  
Insulates stove to prevent heat loss and allows convective air to be warmed against side of stove.

**Single Rod Draft Control**  
Simple and easy to control heat output and size of fire.

**Removable Ash Drawer**  
For safe and easy clean up. Fits seamlessly into design of stove.

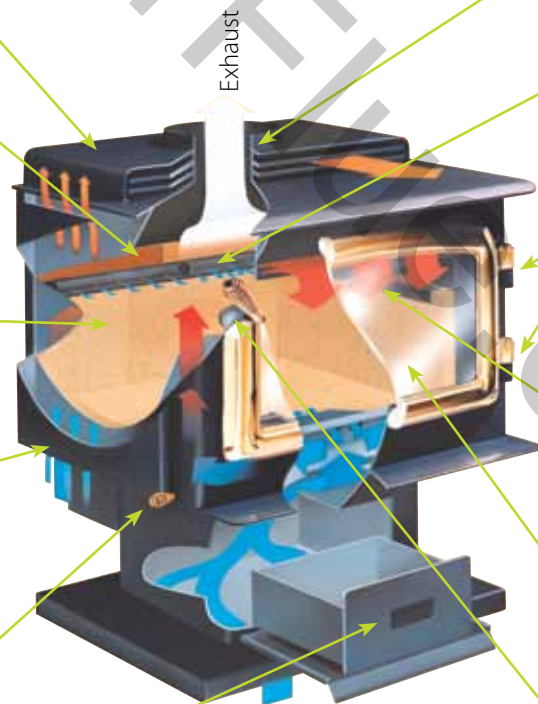

**Heavy Gauge Steel**  
Used throughout the stove to ensure long term durability and increase radiant heat.

**Stainless Steel Air Tubes**  
Injects secondary air into firebox to create reburn. Provides cleaner, more complete combustion.

**Heavy Duty Hinge Pins**  
To ensure long term durability.

**Airwash System**  
Engineered to keep your glass clean automatically by creating airflow across inside of glass. Stove must burn at maximum for 30 minutes for Airwash to occur.

**Ceramic Safety Glass**  
Tested and certified to withstand very high temperatures. Allows heat to radiate through the glass.

**Heavy Duty Cam Latch**  
Ensures airtight seal for controlled airflow.

# Options

## Convenient Ash Removal System



1. Open door



2. Pull out drawer



3. Slide cover on top



4. Carry away



**Leg Ash Drawer**  
A compact ash drawer system is also featured on the leg version.

## Base Options



24 Karat Gold Plated Cast Iron Legs



Brushed Nickel Cast Iron Legs



Black Cast Iron Legs



Black Pedestal

## Cast Iron Doors



Black Cast Iron Door  
(includes nickel handle and hinge caps)



Gold Cast Iron Door

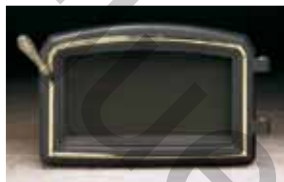

Gold Accent Cast Iron Door



Nickel Accent Cast Iron Door

## Screen Doors



For wood stoves and inserts\*.



For R90 & EX90 wood fireplaces

\* Note: Screen doors are not approved with Alterra wood units (CS1200, CS2400, C11200, C11250) or HearthHeater (H2100)

## Convactor Airmate

The convactor airmate scoops super heated air from the back and top of the stove and directs it to the living area in front. This heat dispersion reduces temperatures behind the unit and allows it to be installed even closer to the wall.



## Powerful Blower

The blower can dramatically increase the circulation of heat in your home. It includes dual speed settings and an automatic heat sensor which turns the blower on and off at predetermined temperatures.



Wood insert blower



# Specifications - Wood Stoves

FRONT WITH PEDESTAL

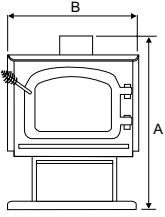

TOP

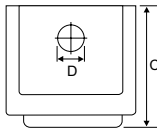

FRONT WITH LEGS

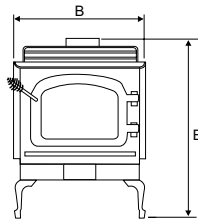

FRONT

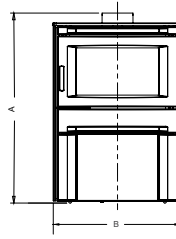

SIDE

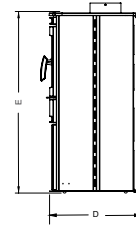

TOP

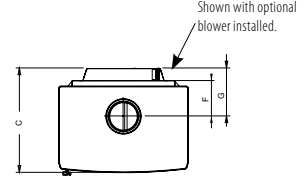

Dimensions	A**	B	C***	D	E**
F1100	30-1/4"	24"	20"	6"	31-11/16"
F2400	34-3/8"	24"	27-3/8"	6"	33-1/2"
S2400	34-3/8"	24"	27-3/8"	6"	35-7/8"
F3100	33-5/16"	28"	25-1/4"	6"	34-3/4"

\*\*Measured to top of flue collar for height

\*\*\* Including Ash Lip

Dimensions	A	B	C	D	E	F	G
CS1200	39-9/16"	26-3/4"	21-3/4"	19-1/16"	37-13/16"	7-5/16"	9-15/16"
CS2400	41-1/8"	25-15/16"	28-7/8"	26-5/16"	39-1/8"	8-5/16"	9-15/16"

	CS1200	CS2400	F1100	F2400	F3100	S2400
Maximum BTU*	55,000	75,000	55,000	75,000	80,000	75,000
Typical Sq. Ft. Heated	600-1200	1000-2200	600-1200	1000-2200	2000-3500	1000-2200
Optimum Efficiency	77.7%	77.0%	77.7%	77%	75.4%	77%
Maximum Log Size	18"	18"	18"	18"	21"	18"
Burn Time (Typical)*	up to 8 hrs	up to 8 hrs	up to 8 hrs	up to 8 hrs	up to 10 hrs	up to 8 hrs
Emissions (grams/hr)	3.0g	3.4g	3.0g	3.4g	4.2g	3.4g
Firebox Size	1.4 cu. ft.	2.3 cu. ft.	1.4 cu. ft.	2.3 cu. ft.	2.9 cu. ft.	2.3 cu. ft.
Flue Size	6"	6"	6"	6"	6"	6"

\* Length of burn time and BTU range depend on type of wood, climate conditions and installation.

## Minimum Clearance to Combustible Materials

Please read the section below carefully as clearances depend on whether the optional airmate convactor or the rear heat deflector is installed on the stove. Measurements "From Unit" are from the top plate of the stove to a side wall or to a corner, and from the rear heat shield to a back wall.

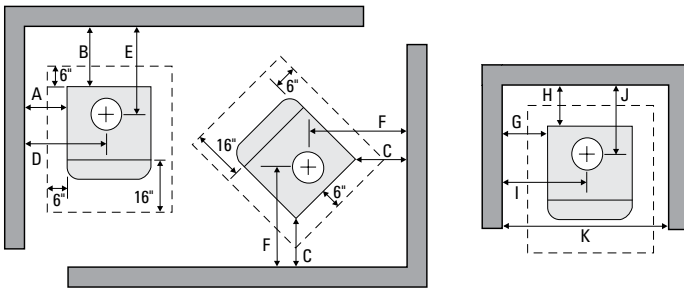

## Minimum Alcove Clearance to Combustible Materials

The Regency® Freestanding models have been alcove approved and must be installed with a listed double wall connector to the ceiling level.

Note: Minimum alcove ceiling height - 84" / Maximum depth of alcove - 36"

Minimum Alcove Clearance	FROM UNIT		FROM FLUE CENTER-LINE		MIN. WIDTH K	
	G	H	I	J		
Alterra CS1200	11"	7"	24-1/2"	14-1/2"	49-1/8"	
Alterra CS2400	15"	6-1/2"	28"	14-7/8"	56"	
F1100	with AirMate	11"	7"	23"	13.5"	46"
	with Rear Deflector	13"	5"	25"	11.5"	50"
S2400	with Step Top	15"	5.5"	27"	12"	54"
F2400	with AirMate	15"	5.5"	27"	12"	54"
	with Rear Deflector	15"	6.5"	27"	13"	54"
F3100	with AirMate	16"	9.5"	30"	16"	60"
	with Rear Deflector	not approved for Alcove				

Residential Installation "C" Vent (Single Wall)	FROM UNIT		FROM CORNER		FROM FLUE CENTER-LINE		
	A	B	C	D	E	F	
Alterra CS1200	13"	11"	8"	26-3/8"	18-1/2"	20-3/4"	
Alterra CS2400	18"	12"	6-1/2"	31"	20-3/8"	19-3/16"	
F1100	with AirMate	13"	11"	8"	25"	17-1/2"	20"
	with Rear Deflector	15"	10-1/2"	11"	27"	17"	23"
S2400	with Step Top	16"	11"	6"	28"	17-1/2"	17-1/2"
F2400	with AirMate	16"	11"	6"	28"	17-1/2"	17-1/2"
	with Rear Deflector	18"	12"	6-1/2"	30"	18-1/2"	19-1/2"
F3100	with AirMate	18"	12"	8-1/2"	32"	18-1/2"	22"
	with Rear Deflector	20"	14"	10-1/2"	34"	20-1/2"	24"

These clearances are certified clearances for the stove, however, the clearance to the combustibles and the single wall stove pipe must also be maintained. You can reduce the stove pipe clearance with a stove pipe heat shield.

## Residential Close Clearance (To be installed with required pipe components)

When the stove is installed as a close clearance residential unit, a listed double wall connector is required from the stove collar to the ceiling level.

Residential Close Clearance (To be installed with required pipe components)	FROM UNIT		FROM CORNER		FROM FLUE CENTER-LINE		
	A	B	C	D	E	F	
Alterra CS1200	11"	7"	7"	24-1/2"	14-1/2"	19-3/4"	
Alterra CS2400	15"	6-1/2"	6"	28"	14-7/8"	18-11/16"	
F1100	with AirMate	9"	5"	3"	21"	11-1/2"	15"
	with Rear Deflector	13-1/2"	5"	5"	25-1/2"	11-1/2"	17"
S2400	with Step Top	15"	5-1/2"	4"	27"	12"	15-1/2"
F2400	with AirMate	15"	5-1/2"	4"	27"	12"	15-1/2"
	with Rear Deflector	15"	6-1/2"	6"	27"	13"	17-1/2"
F3100	with AirMate	16"	9-1/2"	8-1/2"	30"	16"	22"
	with Rear Deflector	20"	12"	8-1/2"	34"	18-1/2"	22"

## Mobile Home Close Clearance (To be installed with required pipe components)

"C" Vent single wall pipe is not approved for mobile home installations. (Refer to mobile home instructions)

Mobile Home Close Clearance (To be installed with required pipe components)	FROM UNIT		FROM CORNER		FROM FLUE CENTER-LINE		
	A	B	C	D	E	F	
Alterra CS1200	11"	7"	7"	24-1/2"	14-1/2"	19-3/4"	
Alterra CS2400	15"	6-1/2"	6"	28"	14-7/8"	18-11/16"	
F1100	with AirMate	11"	6"	6"	23"	12-1/2"	18"
	with Rear Deflector	13"	5"	9"	25"	11-1/2"	21"
S2400	with Step Top	15"	5-1/2"	4"	27"	12"	15-1/2"
F2400	with AirMate	15"	5-1/2"	4"	27"	12"	15-1/2"
	with Rear Deflector	15"	6-1/2"	6"	27"	13"	17-1/2"
F3100	with AirMate	18"	9-1/2"	10"	32"	16"	23-1/2"
	with Rear Deflector	20"	12"	10"	34"	18-1/2"	23-1/2"

# WOOD STOVE FLOOR PROTECTION

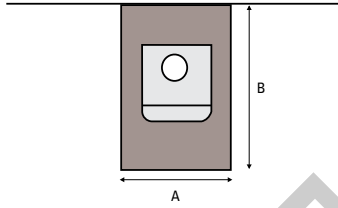

USA FLOOR PROTECTION Flush Wall Hearth Requirements		Residential "C" Vent		Residential Close Clearance		Mobile Home Close Clearance		Alcove		
		A	B	A	B	A	B	A	B	
Alterra CS1200		38-3/4"	39"	38-3/4"	39"	38-3/4"	39"	38-3/4"	39"	
Alterra CS2400		38-3/8"	47-5/16"	38-3/8"	47-5/16"	38-3/8"	47-5/16"	38-3/8"	47-5/16"	
F1100	with AirMate	36"	38"	36"	37"	36"	38"	36"	38"	
	with Rear Deflector	36"	38"	36"	37"	36"	37"	36"	37"	
S2400		with Step Top	36"	46"	36"	45"	36"	45"	36"	45"
F2400	with AirMate	36"	46"	36"	45"	36"	45"	36"	45"	
	with Rear Deflector	36"	46"	36"	45"	36"	45"	36"	45"	
F3100	with AirMate	40"	43"	40"	43"	40"	43"	40"	43"	
	with Rear Deflector	40"	43"	40"	43"	40"	43"	Not approved for alcove		

CANADA FLOOR PROTECTION Flush Wall Hearth Requirements		Residential "C" Vent		Residential Close Clearance		Mobile Home Close Clearance		Alcove		
		A	B	A	B	A	B	A	B	
Alterra CS1200		42-3/4"	43"	42-3/4"	43"	42-3/4"	43"	42-3/4"	43"	
Alterra CS2400		42-3/8"	51-5/16"	42-3/8"	51-5/16"	42-3/8"	51-5/16"	42-3/8"	51-5/16"	
F1100	with AirMate	40"	42"	40"	41"	40"	42"	40"	42"	
	with Rear Deflector	40"	42"	40"	41"	40"	41"	40"	41"	
S2400		with Step Top	40"	50"	40"	49"	40"	49"	40"	49"
F2400	with AirMate	40"	50"	40"	49"	40"	49"	40"	49"	
	with Rear Deflector	40"	50"	40"	49"	40"	49"	40"	49"	
F3100	with AirMate	44"	47"	44"	47"	44"	47"	44"	47"	
	with Rear Deflector	44"	47"	44"	47"	44"	47"	Not approved for alcove		

USA FLOOR PROTECTION Corner Hearth Requirements		Residential "C" Vent				Residential Close Clearance				Mobile Home Close Clearance				
		A	B	C	D	A	B	C	D	A	B	C	D	
Alterra CS1200		38-3/4"	53"	49.5"	22"	38-1/2"	53"	49-1/2"	22"	38-1/2"	53"	49-1/2"	22"	
Alterra CS2400		38-3/8"				38-3/8"				38-3/8"				
F1100	with AirMate	36"	52-3/4"	45-3/4"	21-1/4"	36"	47-3/4"	40-3/4"	16-1/4"	36"	50-3/4"	43-3/4"	19-1/4"	
	with Rear Deflector	36"	57-1/4"	49-1/2"	25"	36"	49-3/4"	42-3/4"	18-1/4"	36"	58-1/4"	50-1/4"	26"	
S2400		with Step Top	36"	57-1/2"	53-1/2"	26-1/2"	36"	55"	52-1/2"	24-3/4"	36"	55"	52-1/4"	24-3/4"
F2400	with AirMate	36"	57-1/2"	53-1/2"	26-1/2"	36"	55"	52-1/2"	24-3/4"	36"	55"	52-1/4"	24-3/4"	
	with Rear Deflector	36"	58"	54"	27"	36"	57-1/2"	53-1/2"	27"	36"	57-1/2"	53-1/2"	27"	
F3100	with AirMate	40"	60-3/4"	53"	24-1/4"	40"	60-3/4"	53"	24-1/4"	40"	60-1/4"	54-1/2"	24-1/4"	
	with Rear Deflector	40"	63-1/2"	53-1/2"	26-1/4"	40"	60-3/4"	53"	24-1/4"	40"	63"	54-1/2"	24-1/4"	

CANADA FLOOR PROTECTION Corner Hearth Requirements		Residential "C" Vent				Residential Close Clearance				Mobile Home Close Clearance				
		A	B	C	D	A	B	C	D	A	B	C	D	
Alterra CS1200		42-3/4"	55"	53"	22"	42-3/4"	55"	53"	22"	42-3/4"	55"	53"	22"	
Alterra CS2400		42-3/8"				42-3/8"				42-3/8"				
F1100	with AirMate	40"	54-3/4"	47-3/4"	19-1/4"	40"	49-3/4"	42-3/4"	14-1/4"	40"	52-3/4"	45-3/4"	17-1/4"	
	with Rear Deflector	40"	59-1/4"	51-1/4"	23"	40"	51-3/4"	44-3/4"	16-1/4"	40"	60-1/4"	52-1/4"	24"	
S2400		with Step Top	40"	59-1/2"	55-1/2"	28-1/2"	40"	57"	54-1/2"	26-3/4"	40"	57"	54-1/4"	26-3/4"
F2400	with AirMate	40"	59-1/2"	55-1/2"	28-1/2"	40"	57"	54-1/2"	26-3/4"	40"	57"	54-1/4"	26-3/4"	
	with Rear Deflector	40"	60"	56"	29"	40"	59-1/2"	55-1/2"	29"	40"	59-1/2"	55-1/2"	29"	
F3100	with AirMate	44"	62-3/4"	55"	22-1/4"	44"	62-3/4"	55"	22-1/4"	44"	62-1/4"	56-1/2"	22-1/4"	
	with Rear Deflector	44"	65-1/2"	55-1/2"	24-1/4"	44"	62-3/4"	55"	22-1/4"	44"	65"	56-1/2"	22-1/4"	

### Corner Installations

If the rear clearance to combustibles is less than 6", for corner installations the corners may be angled to take advantage of the closer clearances.

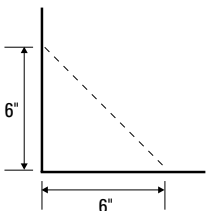

### Floor Protection

A combustible floor must be protected by non-combustible material (like tile, concrete board, or certified to UL-1618 or as defined by local codes) extending beneath the heater and a minimum of 6" (USA) or 8" (250mm) (Canada) from each side and minimum 16" (USA) or 18" (450mm) (Canada) from the front face of stove and minimum 6" (USA) or 8" (250mm) (Canada) or the rear clearance to combustibles, whichever is smaller, from the rear of the stove.

When installed with horizontal venting, non-combustible floor protection must be installed beneath the flue pipe and extend 2" (51mm) beyond each side.



# Specifications - Wood Inserts

	C11200	C11250	I1200	I2400	I3100	H2100
Maximum BTU*	55,000	55,000	55,000	75,000	80,000	70,000
Typical Sq. Ft. Heated	600-1000	600-1000	600-1000	1000-2000	1800-3000	800-1500
Optimum Efficiency	77.7%	77.7%	77.7%	77%	75.4%	84.9%
Maximum Log Size	18"	18"	18"	18"	21"	18"
Burn Time (Typical)*	up to 8 hrs.	up to 8 hrs.	up to 8 hrs	up to 8 hrs	up to 10 hrs	up to 8 hrs
Emissions (grams/hour)	3.0g	3.0g	3.0g	3.4g	4.2g	3.5g
Firebox Size	1.4 cu. ft.	1.4 cu. ft.	1.4 cu. ft.	2.3 cu. ft.	2.9 cu. ft.	1.6 cu. ft.
Flue Size	6"	6"	6"	6"	6"	6"

\* Length of burn time and BTU range depend on type of wood, moisture content, climate conditions and installation.

Minimum Fireplace Opening		C11200	C11250	I1200	I2400	I3100	H2100
Width (front)		25"	25"	23"	25"	28"	8"
Height		19-5/8"	23"	19"	21-1/2"	25"	20" (without legs) 28" (with legs)
Depth	(w/ standard flue adaptor)	15-1/16"	15-1/16"	13-3/4"	17"	17"	--
	(w/ offset flue adaptor)	17-11/16"	17-1/16"	16-1/2"	--	--	--

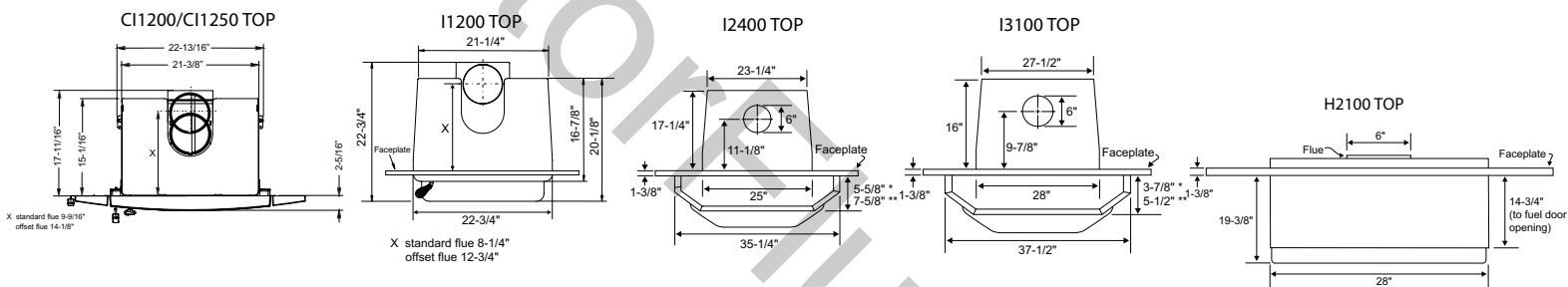

\* To fuel door opening  
\*\* Top surface depth

Dimensions	C11200	C11250	I1200	I2400	I3100	H2100
Firebox Height	18-13/16"	22-1/8"	18-3/4"	20-7/8"	22-3/4"	22-1/2"
Height to top of Flue Collar	19-9/16"	22-13/16"	19-1/2"	21-1/4"	23-1/8"	20" (without legs) 28" (with legs)
Regular Faceplate Width	35-15/16"	35-15/16"	38"	40"	44"	40-1/4"
Regular Faceplate Height	22-9/16"	25-13/16"	26-1/8"	30"	32"	30"
Oversize Faceplate (W x H)	custom size & backing plate available	custom size & backing plate available	44" x 30-1/8"	48" x 33"	50" x 34-1/2"	48" x 33"

\* including ashlip

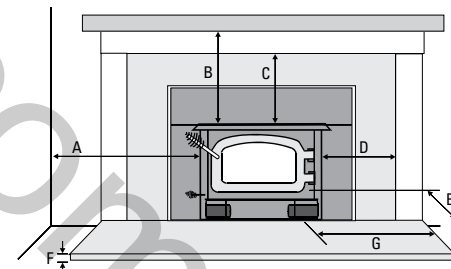

## Masonry & Factory Built Fireplace Clearances

The minimum required clearances to combustible materials when installed into a masonry fireplace are:

	Adjacent Side Wall (to side)	Mantel (to top)	Top Facing (to top)	Side Facing (to side)	Min. Hearth Extension*		Min. Hearth Elevation*	Min Hearth Side Width**	
					E (USA)	E (Canada)		F	G (USA)
C11200	15"	20"	14"	7-3/8"	16"	18"	1-1/2"	6"	8"
C11250	15"	20"	14"	7-3/8"	16"	18"	1-1/2"	6"	8"
I1200	15"	20"	14"	7-3/8"	16"	18"	1-1/2"	6"	8"
I2400	11"	20"	12"	8"	16"	18"	1/2"	8"	8"
I3100	13"	19"	18"	6-1/2"	16"	18"	1-1/2"	6"	8"
H2100	10"	25"	14"	8-1/2"	16"	18"	1-1/2"	6"	8"

\* Note: If the hearth extension is flush with the floor (item F) it must extend 19.5 in. in front of the body face (item E) (I1200, I3100 & H2100 only).

\*\* Note: Hearth extension width (G) is measured from edge of fuel door to side of hearth.

## Hearth Heater Minimum Fireplace Openings

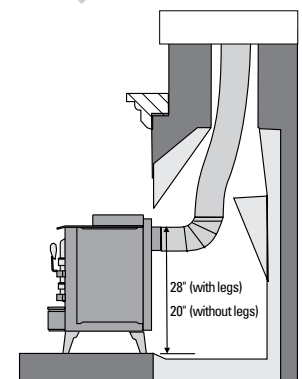

Illustrates Hearth Heater with classic leg option.

# Specifications - Wood Fireplaces

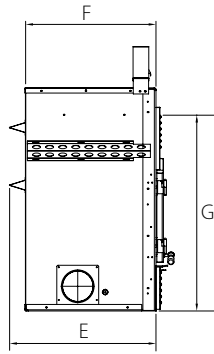
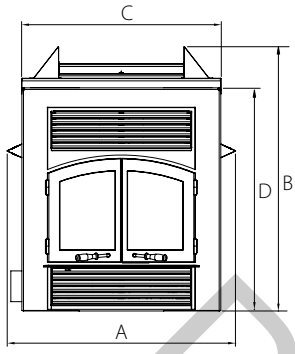

Dimensions	R90	EX90
A	43-5/8"	43-5/8"
B	50-1/2"	50-1/2"
C	38"	38"
D	42-5/8"	42-5/8"
E	28"	28"
F	25"	25"
G	37-3/8"	29-1/8"
H	--	38-3/4"
I	--	33-3/4"
J	--	43"

SPECIFICATIONS	R90	EX90
Maximum BTU*	70,000	70,000
Typical Sq. Ft. Heated	1,000-2,200	1,000-2,200
Efficiency (EPA)	74%	74%
Maximum Log Size	20"	20"
Burn Time (Typical)*	up to 8 hrs	up to 8 hrs
Emissions (grams/hr)	3.72g	3.72g
Firebox Size	2.5 cu. ft.	2.5 cu. ft.
Flue Size	8"	8"

\*Length of burn time and BTU range depend on type of wood, moisture content, climate conditions and installation

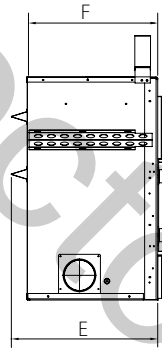
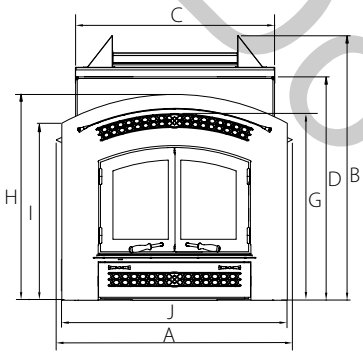

## FRAMING

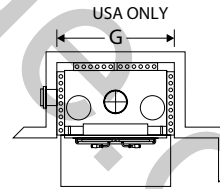
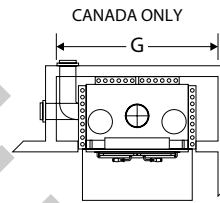
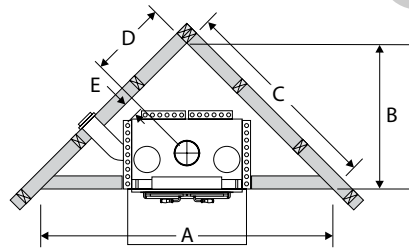
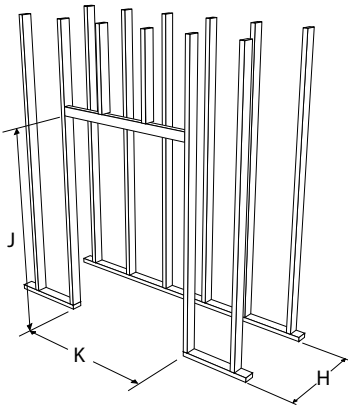

Framing	USA	Canada
A	96-1/4"	115-3/8"
B	48-1/8"	57-5/8"
C	68"	81-1/2"
D	24-1/2"	31-1/4"
E	3"	9-3/4"
G	44"	60"
H	28"	28"
J	50-3/4"	50-3/4"
K	44"	44"

**US only:** Chase must be ventilated with one 30 square inch vent grill. The vent grill must draw air from inside the home and not from outside.

## CLEARANCE TO COMBUSTIBLES

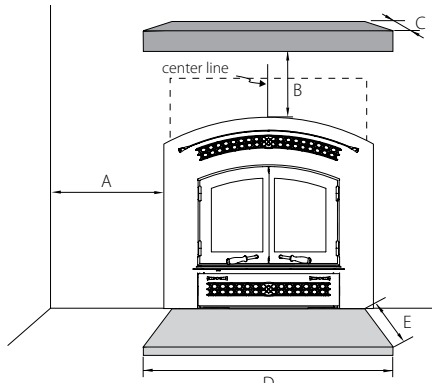
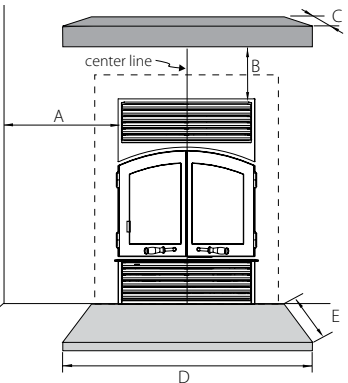

Minimum Clearance to Combustibles R90 / EX90	USA	Canada
A Side Wall From Louver Opening (EX90: to surround edge)	18"	24"
B Mantel Height (min.) From Louver Opening	18"	18"
C Mantel Depth (max.)	10"	10"

Non-Combustible Hearth Requirement		
D	Hearth Width	40"
E	Hearth Depth	18"

NOTE: All product specifications are subject to change without notice. Before installing refer to the relevant product manual for full and up to date information.





# BIOMASS STOVES TAX CREDIT

The US government has announced a renewable energy incentive for 2011 designed to reduce our reliance on foreign oil and increase clean, efficient home heating with wood and pellet fuels. The US Biomass Tax credit allows for a 10% consumer tax credit of up to \$300 per year on approved wood and pellet burning fireplace products purchased between January 1, 2011 and December 31, 2011.

ALL Regency and Hampton wood and pellet fireplaces, inserts and stoves exceed 75% efficiency standard and qualify for this US tax credit. That's 10% back on ANY Regency and Hampton wood or pellet product you purchase.

For up to date information visit our web site: [www.regency-fire.com](http://www.regency-fire.com)

## fireplace selection worksheet

We want you to enjoy your beautiful Regency fireplace for years to come. To help you figure out which product is just right for your home, fill in the following worksheet. Once complete, visit your nearest Regency dealer. Your professional Regency dealer will assess your needs - including local building codes - and install your Regency.

### 1. BASIC PRODUCT FUNCTION QUESTIONS

- a. I would like my insert to provide me with:  Supplemental heating  Priority heating
- b. The room/rooms I would like to heat are: \_\_\_\_\_ Square feet

### 2. FIREPLACE PRODUCT TYPE AND MEASUREMENTS

- a. I am:  Installing a new fireplace  Installing into an existing fireplace
- b. Fill in the following measurements:
- Ceiling Height: \_\_\_\_\_
- Location in the room: \_\_\_\_\_
- Flooring material: \_\_\_\_\_
- Wall material: \_\_\_\_\_
- Ceiling material: \_\_\_\_\_
- c. What is the:
- Width (front) \_\_\_\_\_
- Width (back) \_\_\_\_\_
- Height \_\_\_\_\_
- Depth \_\_\_\_\_
- d. Fireplace opening dimensions

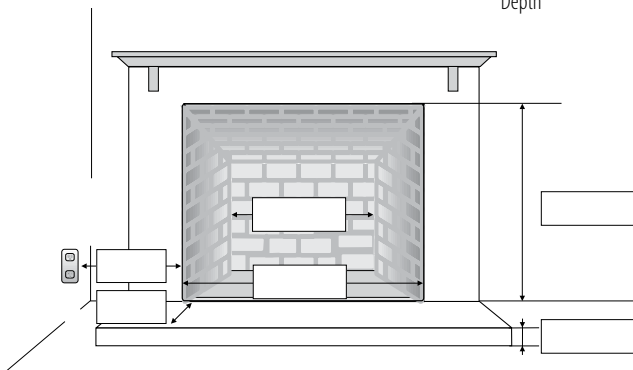
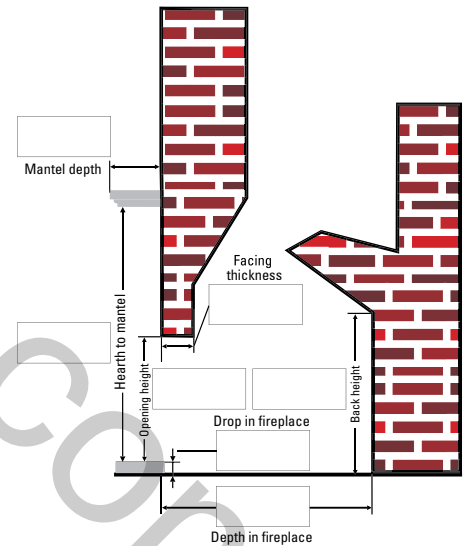

[www.regency-fire.com](http://www.regency-fire.com)

your regency dealer