

CLEAN DOESN'T MEAN COMPROMISE



R RENAISSANCE
FIREPLACES



Rumford 1000

The Renaissance Rumford® 1000 is the ideal wood-burning fireplace. Its patented design delights the senses with the sound of crackling wood, heat from its flame and visually offering the perfect focal point for any room. When the glass door is closed, there is no heat loss up the chimney, making it more efficient than a conventional masonry fireplace.





Rumford 1500

The Renaissance Rumford® 1500 is the largest of our patented fireplace designs. It is the ultimate in size and performance with a firebox large enough to fill any room with light and heat.



Vermiculite Panel pattern shown.



Linear 50

Contemporary wood-burning at its finest. At 50" wide, the wall-to-wall fire of the L50 is an experience unlike any other. As with all Renaissance Fireplaces, the door and screen open with an elegant guillotine system. The L50 includes a Heat Recovery System (HRS) to distribute heat throughout the home using ducts.



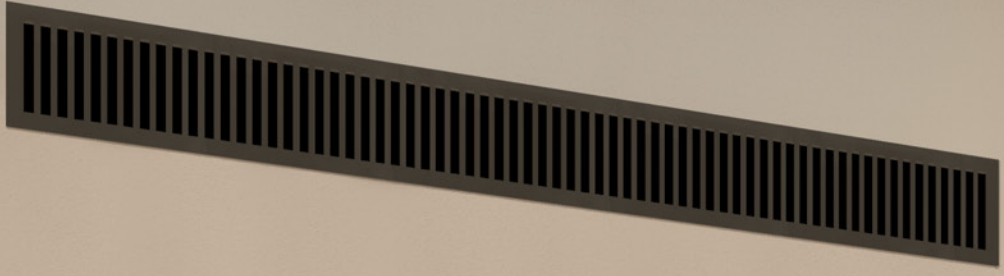



Heat Recovery System (HRS)

Renaissance Linear 50 Grills

Rectangular Grills



Four 13 1/2" x 6" rectangular grills are provided with the Linear 50.

Options:

Square Grills for an 8' Ceiling

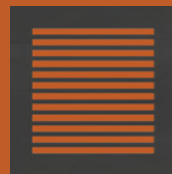

These 13" grills are required for installation in a room with a ceiling between 8' and 9' high. They replace the rectangular hot air outlet grills provided with the Linear 50.

Long Linear Grills



These Intake or Outlet grills (52 1/2" x 6") are front-facing and replace the rectangular grills provided with the Linear 50.

The problem with other wood burning systems



Conventional Masonry Fireplaces

Heat Loss

The constant flow of warm room air up the chimney can actually cool the home rather than heat it.

Expensive

Not only is fireplace work expensive, but the architecture must be able to support the weight.

High Emissions

They still burn as dirty as they did centuries ago, with emissions up to 60 g/hr.

Zero Clearance Fireplaces

Durability

Thin materials are used to reduce production cost.

Air Cooled Chimney

Air cooled chimneys are inefficient because they allow cold air into the envelope of the home.

High Emissions

With virtually no improvement in emissions, they burn as dirty as an open fire.

Freestanding Wood Stoves

Small Fire

Even the largest wood stoves have a relatively small viewing space for the fire.

Limited Ambiance

Without hearing the crackle and pop of the fire, much of the ambiance of wood-burning is lost.

Limited Design Choices

Despite a choice of colors and sizes, wood stoves limit the room's design options.

Renaissance Fireplaces® is the solution to wood-burning problems



Sealed Door

Your Renaissance door seals warm air inside the home where it belongs.

Less expensive than masonry

With no footing required to support the fireplace, pre-assembled units cost less and install easily.

Clean Burning

Winner of a U.S. EPA Clean Air Excellence Award for outstanding, innovative efforts in improving air quality.



Installation Ease

Even though the smallest Renaissance model is over 800 lbs of solid steel, it is still light enough to not require additional floor support.

Insulated Chimney

Prevents cold air from entering the home and improves appliance performance.

Massive Fire

No other fireplace burns as big, bright and beautiful as a Renaissance Fireplace®.

Creates Ambiance

Listen to the crackle and pop of the fire when the built-in screen is closed.

Freedom of Design

Our fireplaces are a blank canvas which you can adapt to your personal style.

What makes Renaissance the ultimate wood-burning fireplace?

The Fire. Renaissance Fireplaces® light faster, produce larger flames, generate fewer emissions and heat more than any other existing open wood fireplace. The fire is so big and bright that it puts all other wood-burning appliances to shame. If you have not experienced the fire in a Renaissance, now is the time.

The Nostalgia. A luxury wood-burning fireplace should create a feeling of nostalgia. Most Renaissance customers grew up with a conventional wood-burning fireplace. Our goal is to recreate those positive feelings, without any of the drawbacks like inefficiency or smoke in the home.

No other fireplace has this technology

State-of-the-Art Materials

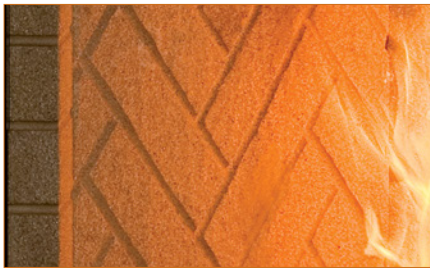

Every material has been specially selected to make the fire burn taller, brighter, hotter and cleaner.

Specialty firebox liners are available in two different materials. The Refractory Bricks come in a running bond pattern and are built to last a lifetime. The Vermiculite Panels* come in a herringbone pattern and are designed for high performance. Vermiculite Panels offer increased efficiency, over time, cracks and visible wear are normal.



Ceramic glass transmits more heat than tempered glass and is able to withstand drastic temperature changes. It also has a rich brown hue, unlike the greenish hue of tempered glass.

Blanket insulation is the ultimate in protection and efficiency. The fireplaces are wrapped in layers of blanket insulation, which makes them safer and increases efficiency by preventing heat loss.

Chimney: the Engine that Drives the Fireplace

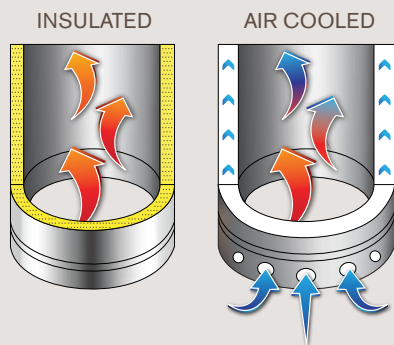

Most fireplaces use air cooled chimneys which circulate cold air past the inner flue to reduce the temperature. A cold flue makes establishing a draft difficult and increases the formation of creosote in cold weather.

Renaissance Fireplaces® is certified exclusively for use with Model RIS chimneys. They are heavy duty insulated chimney made with high temperature insulation and superior stainless steel. They warm up faster, draw better and accumulate less creosote than air cooled chimneys.

So no other fireplace burns like it

The Rumford Fireplace Advantage*

The Rumford shape is known to many as the most efficient of all firebox designs. We have taken this renowned design to the next level by combining it with high tech materials and modern fabrication techniques. The end product delivers breathtaking fires and a greener planet.

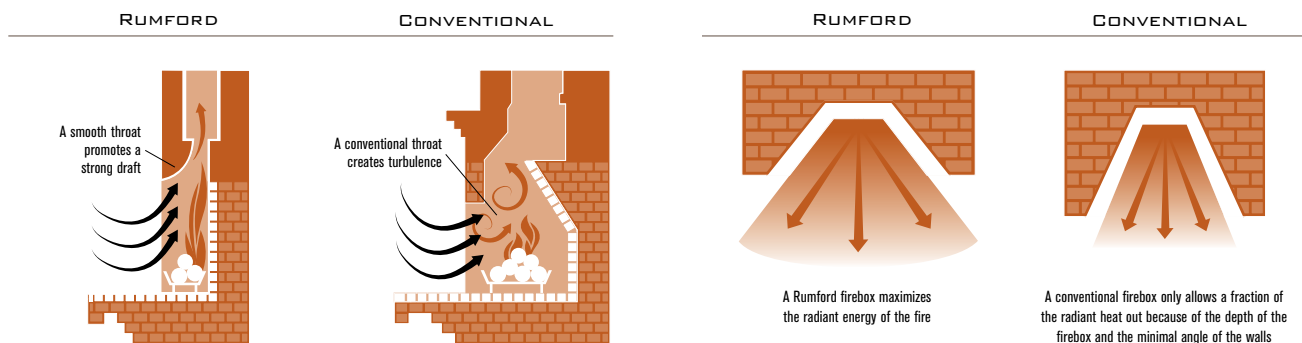

Being Environmentally Responsible

The Renaissance Rumford® 1000 was the first (and only) fireplace ever to win an award from the United States Environmental Protection Agency (EPA). The Clean Air Excellence Award recognizes only the products and companies that engage in outstanding, innovative efforts to improve air quality.

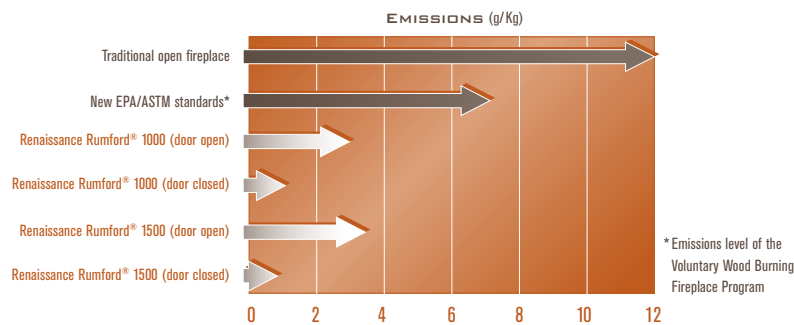

Guillotine Door and Screen

Renaissance doors and screens lift upwards, disappearing into the facing above the fireplace. This provides a clear view of the fire that is free of mechanical parts.

Top quality hardware, detailed engineering and precision laser fabrication enable you to adjust the way your fireplace burns.

When the door is closed, outside air is used for combustion. This prevents heat loss and conserves the efficiency of your home. Having the door closed is the safest way to enjoy a fire and with its side swinging feature, it opens outward for easy cleaning.



INSERT THE HANDLE



PUSH DOWN TO CLOSE

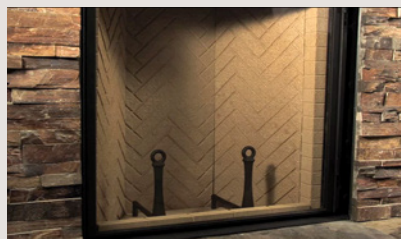

BURN SAFELY, WITHOUT HEAT LOSS

If you enjoy hearing the crackle and pop of the fire, simply close the built-in firescreen. The firescreen doesn't block the view of the fire, but prevents embers from escaping. When the screen and door are closed simultaneously, the screen acts as a safety barrier for children and pets.



HOLD THE SCREEN HANDLES

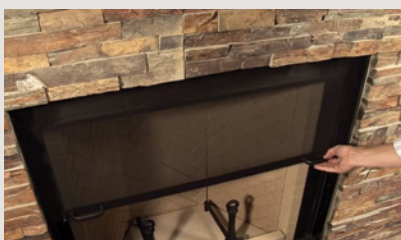

PULL THE SCREEN DOWNWARDS



ENJOY A CRACKLING FIRE

How it Works

- 1 Classic Rumford firebox proportions: the most efficient of all firebox designs*
- 2 Guillotine Door and Screen
- 3 The smooth Rumford throat achieves better performance*
- 4 Blanket Insulation is the ultimate in protection and efficiency
- 5 Specialty Refractory Panels create hotter fires and lower emissions.



	Rumford 1000B	Rumford 1500B	Linear 50
Outside Dimensions	51"W x 80 1/4"H x 28 1/4"D	59 1/8"W x 87 3/4"H x 32 1/2"D on a combustible floor H = 93"	70 3/8"W x 66 3/8"H x 28 3/4"D
Shipping Weight	720 lbs	1,085 lbs	950 lbs
Shipping Crate Size	56"W x 78 3/4"H x 31 1/4"D	66 1/2"W x 81 3/4"H x 36 1/4"D	70 1/4"W x 69 1/2"H x 32 1/2"D
Door	Counterweighted Guillotine Operation		
Screen	Counterweighted Guillotine Operation		
Door Opening Size	34"W x 37"H	42 3/4"W x 42"H	50 7/16"W x 19 7/8"H
Glass Viewing Size	29 1/2"W x 31 1/2"H	37 1/4"W x 36 1/2"H	45 7/8"W x 15 3/8"H
Firebox Dimensions	27 1/2"W front 13 1/2"W back 12 3/4" deep	35 1/2" W front 21 3/4"W back 13" deep	44 1/2"W x 14"D
Chimney Size	10" RIS	12" RIS	10" RIS
Minimum Chimney Height	12' (more with elbows)	12' (more with elbows)	12' (more with elbows)
Touch up Paint Color	Stove Bright Metallic Black		
Maximum Fuel Load	3-4 medium logs	4 medium logs	4-5 medium logs
Maximum Log Length	20"	22"	24"
Gas Log Provision ¹	Yes	Yes	Yes
HRS (Heat Recovery System)	N/A	N/A	Included with fireplace: Two 10" dia. outlet ducts – 5' length Two 10" dia. intake ducts – 5' length
HRS Grills	N/A	N/A	Four 13 1/2" x 6" wall grills

Options

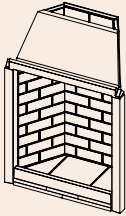
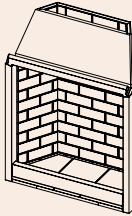
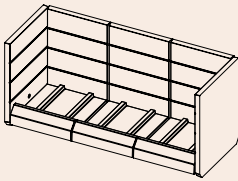
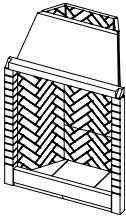
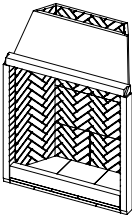
HRS extensions	N/A N/A	N/A N/A	EO-DUCT = 5' outlet extension EO-CID = 5' intake extension
HRS Grills	N/A N/A N/A	N/A N/A N/A	EO-LLG-IN (Long linear intake grills): 52 1/2" x 6" EO-LLG-OUT (Long linear outlet grills): 52 1/2" x 6" EO-SG (Wall grills for 8' ceilings): 13" x 13"
Outside Air Kit	FO-INT	FO-INT	FO-INT
Refractory Brick Durable high temperature refractory reinforced with stainless steel pins.			 Included with fireplace
Vermiculite Panels High performance panels. Cracks and wear are more likely.			Not available

Clearance to Combustible Materials

Back	0"	0"	0"
Sides	0"	0"	0"
Floor	0"	0"	0"
Hearth Requirements	45"W x 24"D 0.54 R-value	67"W x 24"D 2.2 R-value	74 1/2"W x 20"D Ember protection only

Certification

Safety	ULC S-610 / UL127		
Patents	U.S. Patent No. 8,479,723 Canadian Patent Pending	U.S. Patent No. 8,479,723 Canadian Patent Pending	
Emissions	Surpasses emissions of the EPA Voluntary Wood Burning Fireplace Program. Defined as a fireplace by the 2015 particulate emissions standards. Door Open 3.0 g/kg Door Closed 1.0 g/kg	Surpasses emissions of the EPA Voluntary Wood Burning Fireplace Program. Defined as a fireplace by the 2015 particulate emissions standards. Door Open 3.4 g/kg Door Closed 0.68 g/kg	Defined as a fireplace by the 2015 NSPS particulate emissions standards.

16 Note 1: These fireplaces may be drilled out to accept an after-market gas log assembly.
You may not install a gas lighter in any Renaissance fireplace because the high firebox temperatures will burn out the log lighter very quickly.

Fireplace Specifications

▼ Rumford 1000B

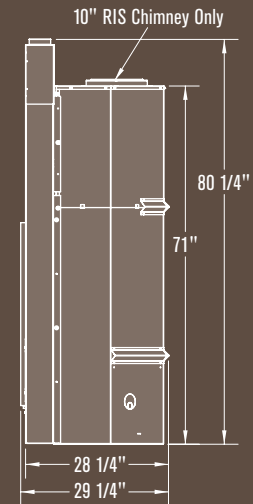
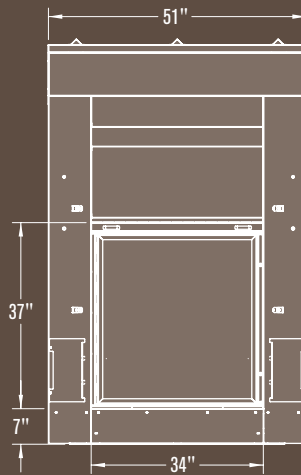
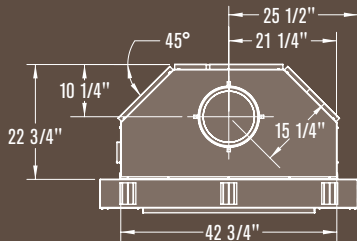

▼ Rumford 1500B

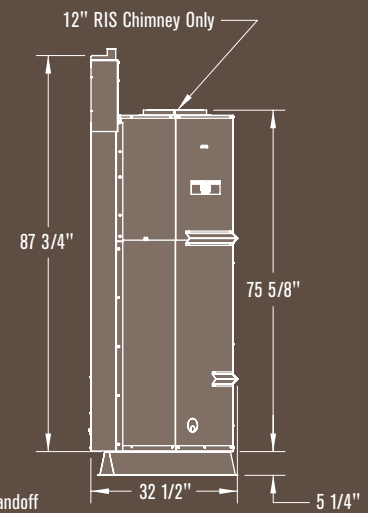
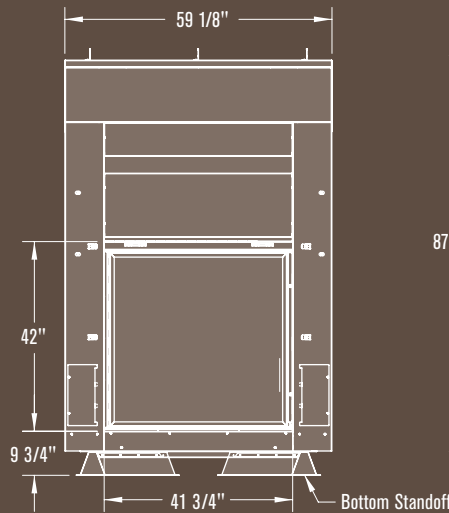
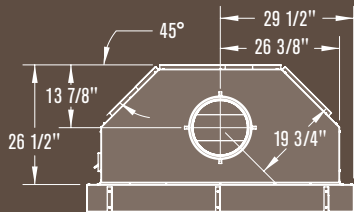

▼ Linear 50

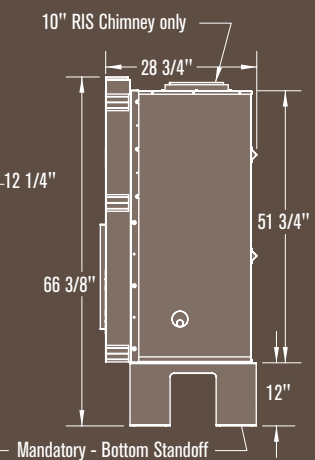
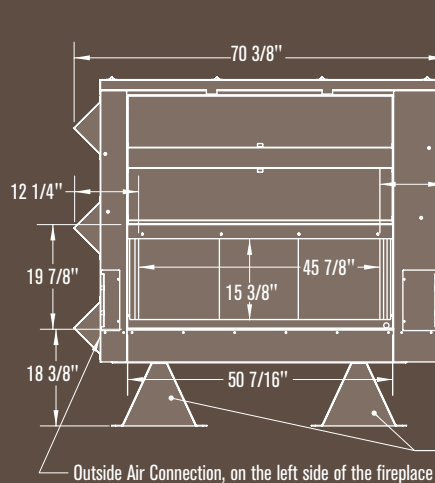
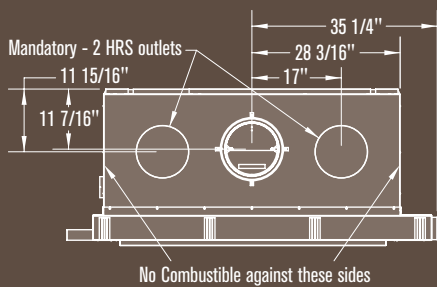





All Renaissance Fireplaces®
are covered by a comprehensive
30 year warranty

RENAISSANCE FIREPLACES®, A DIVISION OF
INDUSTRIAL CHIMNEY COMPANY

400 J-F KENNEDY, ST. JEROME
(QUEBEC) CANADA J7Y 4B7

TELEPHONE: (450) 565-6336
FAX: (450) 565-6519

PLEASE VISIT OUR WEBSITE FOR MORE INFORMATION
WWW.RENAISSANCEFIREPLACES.COM



RR-CAT_2016-08



CLEAN DOESN'T MEAN COMPROMISE