

valor THE ORIGINAL
RADIANT GAS FIREPLACE

G4

Legend Insert Series



Edgemont front in Brushed Nickel with small Backing plate, Pebble Beach Driftwood and Black Fluted liner.

Design and Efficiency

The **Valor**[®] Legend Insert Series has been providing reliable home comfort in North America for over two decades. The G4, the largest of the series, features the choice of six fuel beds along with several trims to suit your style. With Valor's advanced radiant heat technology, the G4 is sure to transform any room in your home into your new comfort zone.

Design

- Fits existing large fireplace openings without sacrificing presence or performance.
- Bold flames highlight an impressive viewing area.
- Proportional surrounds compliment your hearth.
- Fronts in Vintage Iron, Brushed Nickel, Bronze and Black; as well as Hammered Vintage Iron, Copper, and Oiled Bronze.
- Fuel beds include two Traditional Log designs, Rocks, Pebble Beach Driftwood, Murano Glass and Decorative Glass designs.
- Glowing fuel effects radiate and convect warmth.

Performance

Engineered for performance and efficiency, the G4

- increases your home's overall energy efficiency.
- provides ease-of-use heat control.
- effectively distributes radiant warmth and comfort.
- strategically distributes warmth to specific areas of your home with **Zone Heating**.

Exclusive to Valor: **AutoFire**[™]

Automatically adjusts for maximum performance

1. Makes initial startup easier by automatically adjusting air flow within the fireplace.
2. Provides improved operating efficiencies—saving you energy.
3. Fine tunes your fireplace for peak performance in ways fixed restrictors cannot—an industry first.



Please note:
images may vary from actual product.

5" Floating front in Bronze

- Traditional Logs (deluxe)
- Black Fluted liner



Select a front:

① EDGEMONT

Edgemont fronts are slim—about 2" wide on all sides—and slightly offset from the backing plate which sits flat against the wall.



Hammered Copper
Small Black backing plate



Brushed Nickel
Medium-sized Black backing plate



Hammered Vintage Iron
Small Black backing plate



Bronze
Small Black backing plate



Hammered Oiled Bronze
Medium-sized Black backing plate

② FLOATING 2.5"

The **2.5" Floating front** is offered in Vintage Iron. It sits proud of the wall or the optional backing plate by 1.5".



Vintage Iron



Vintage Iron
Black backing plate

Select a liner:

① Black Fluted

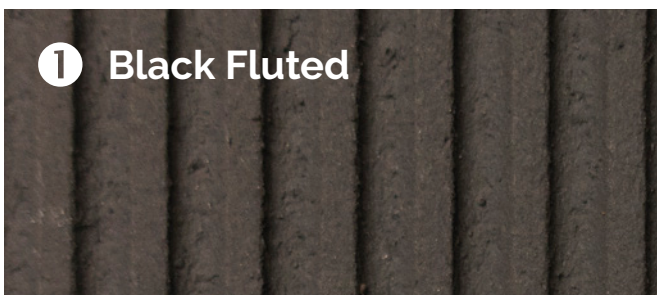

② Reflective Glass



3 FLOATING 5"

The **5" Floating fronts** are 3 or 4-sided, and sit proud of the wall or optional backing plate by 1.5".



Vintage Iron



Vintage Iron



Bronze
Black backing plate



Bronze

4 SQUARE 5.75"

Square fronts, 5.75", are 3-dimensional in shape, the frame like a box. Square fronts are 1.75" deep.



Vintage Iron



Black
Black riser

3 Red Brick

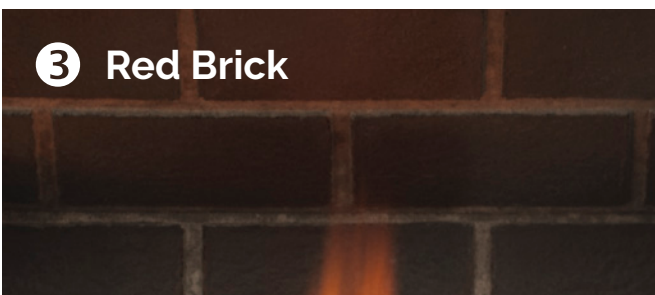

4 LedgeStone

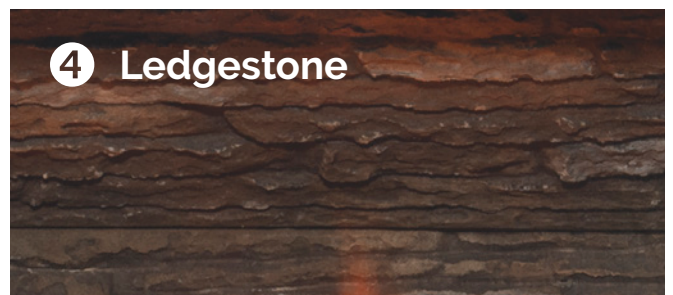

**2½" Floating front
in Vintage Iron**

- Traditional Logs
- Black Fluted liner



Select a finish:

Seven custom finishes are available on select steel fronts listed below:

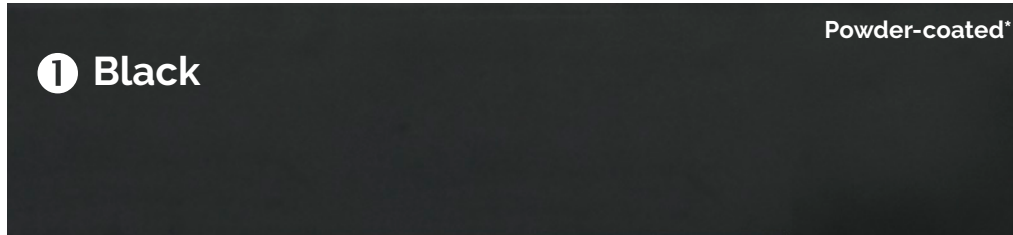

Available on

- Square 5¾" front
- All Backing plates



Available on fronts

- Floating 2.5
- Floating 5"
- Square, 5.75"



Available on

- Edgemont front



Available on fronts

- Edgemont
- Floating 5"

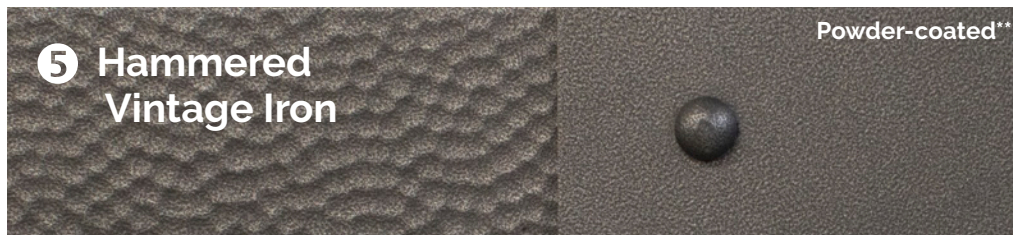

Available on

- Edgemont Hammered front

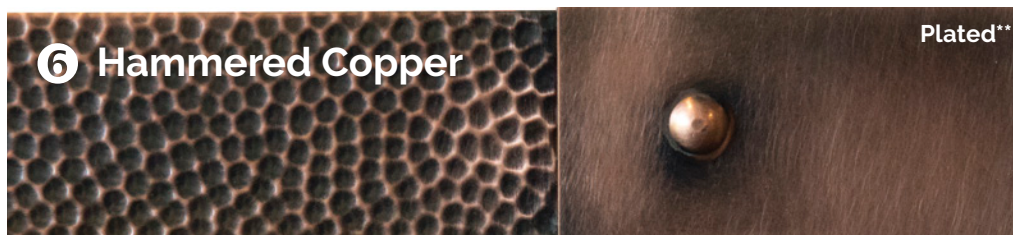

Available on

- Edgemont Hammered front

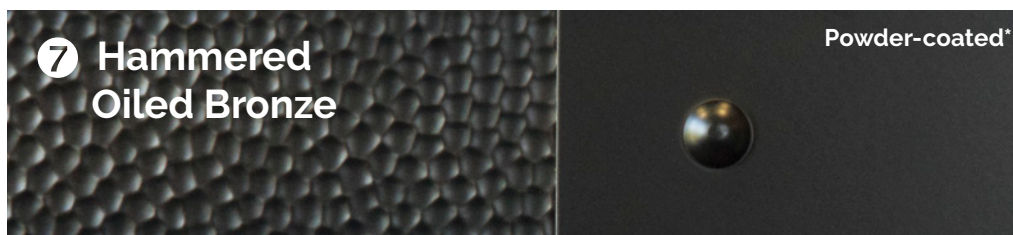

Available on

- Edgemont Hammered front

*Electrostatic powder-coated epoxy paint for a rich, durable finish.

**Electroplated and hand-finished for a durable, artisan appearance.

Select a fuel bed:

Traditional Logs, Deluxe (785KL)

- Detailed craftsmanship shows in the natural look of the logs.
- Glowing embers add to ambience and enhance radiant warmth.
- Engineered to provide excellent radiant performance.



Pebble Beach Driftwood (785Y)

- Specially designed to direct radiant heat into your living space.
- Captivating flames on both high and low settings highlight the realistic detail of the log designs.

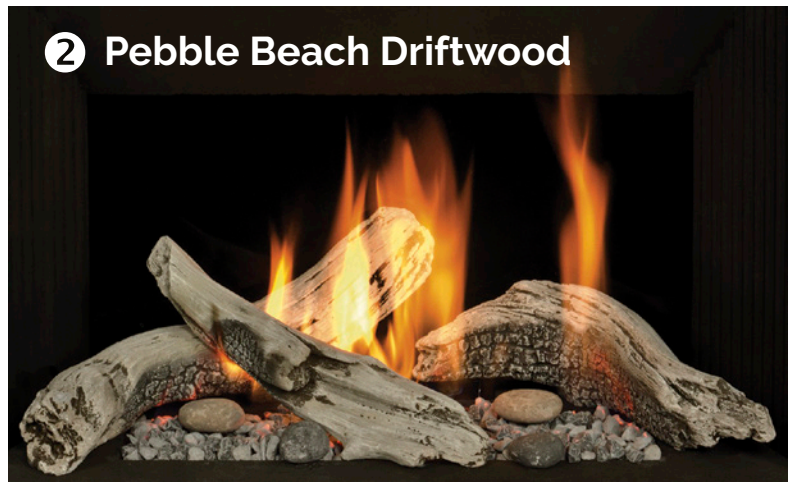

Murano Glass (785Y)

- Inspired by the island of Murano's *fire on water* heritage.
- Flames illuminate clear tumbled glass, casting reflections on a perimeter glass base.



④ Traditional Logs



Traditional Logs (780K)

- Refined adjustment of the fire, with a low setting of 6500 BTUs.
- Distributes a steady, even glow throughout the firebox.
- Reflective glass base illuminates the hearth and highlights realistic flames.
- Ceramic logs strategically placed to offer the most radiant warmth possible.

⑤ Rocks



Rocks (780K)

- Offers a contemporary feel.
- Driftwood and river rocks nestle gently on a sand base, reflecting steady flames and impressive Valor heat.
- Captivating flames on both high (28,000 BTU) and low (6500 BTU) settings.

⑥ Decorative Glass



Decorative Glass (785Y)

- Flames illuminate clear tumbled glass, casting reflections on a perimeter glass base.
- Full bed of glass for maximum impact.

G4 COMPONENTS

FUEL BEDS WITH BURNERS

Direct Vent Engine	Traditional Logs	782LSK	Stainless Steel Burner: Natural Gas or Propane	780KN 780KP
	Rocks	781RSK		
	Traditional Logs (deluxe)	included with burner	Ceramic Burner: Natural Gas or Propane	785KLN 785KLP
	Pebble Beach Driftwood	1101DWK		
	Murano Glass	785XDGM	Ceramic Burner: Natural Gas or Propane	785YN 785YP
	Decorative Glass	785XDGS		

LINERS

Fluted Black	788FBLV2	
Reflective Glass	787RGL	
Red Brick	789VRLV2	
Ledgestone	786LSLV2	
Reflective Glass Panel	785RGP	suits Black Fluted liner

FRONTS: Floating And Square

Floating, 2.5"	Vintage Iron	3-sided	790FTV	36" w x 25½" h
Floating, 5"	Vintage Iron	3-sided	792FTV	40⅝" w x 27⅝" h
	Bronze		792FTZ	
	Vintage Iron	4-sided	798FFV	40⅝" w x 32½" h
	Bronze		798FFZ	
Square, 5.75"	Black	3-sided	791STB	43" w x 28⅝" h
	Vintage Iron		791STV	

BACKING PLATES: for above fronts

Black, small	3-sided	794BPB	46" w x 31" h (not for use with 4-sided front)
Black, large New		794BPB-1	48" w x 32⅜" h (not for use with riser)

RISERS

Riser, Black	793RTB	46½" w x 2½" h; fit specific fronts and backing plates. See manual for details.
Riser, Vintage Iron	793RTV	

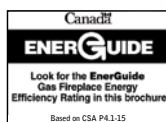
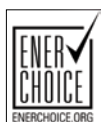

Improved by
Valor AutoFire™

FUEL
BTU/hour

model	fuel	max. input	min. input	EnerGuide Rating*	max. output w/o fan*
780KN	NG	28,000	6,500	70.02%	20,933
780KP	LPG	28,000	13,000	70.02%	20,933
785KLN	NG	28,000	17,500	70.00%	20,773
785KLP	LPG	28,000	13,000	70.00%	20,773
785YN	NG	28,000	15,000	70.02%	20,664
785YP	LPG	28,000	13,000	70.05%	19,344

* EnerGuide Ratings and Outputs have been determined without a fan/blower, using the CSA P4.1-15 test method

Certified to ANSI Z21.88-2014/ CSA 2.33-2014 Vented Gas Fireplace Heater American National Standard CGA - 2.17-91 Gas Fired Appliances for use at High Altitudes

FRONTS: Edgemont

Edgemont	Brushed Nickel	799EDFN
	Bronze	799EDFZ
	Hammered Vintage Iron	784EHFV
	Hammered Copper	784EHFC
	Hammered Oiled Bronze	784EHFOZ

BACKING PLATES: for Edgemont Fronts

Black, 3-sided, small	799BPB-1	39½" w x 27" h
Black, 3-sided, medium	799BPB-2	46" w x 31" h
Black, 3-sided, large New	799BPB-3	48" w x 32¾" h (not for use with riser)



The ValorStat Max Remote

- Select, adjust and program your desired temperature.
- Program the built-in timer to turn your fireplace ON before you wake up and DOWN when you go to bed.
- Turn your pilot light ON and OFF with your programmable remote control. You'll never need to get on your hands and knees to light the pilot again!

Optional Wall Switch (1265WSK)



G4 DIMENSIONS, VENTING AND CLEARANCES

Always refer to the manual for complete installation instructions.

DIMENSIONS

window: 28" w x 18" h

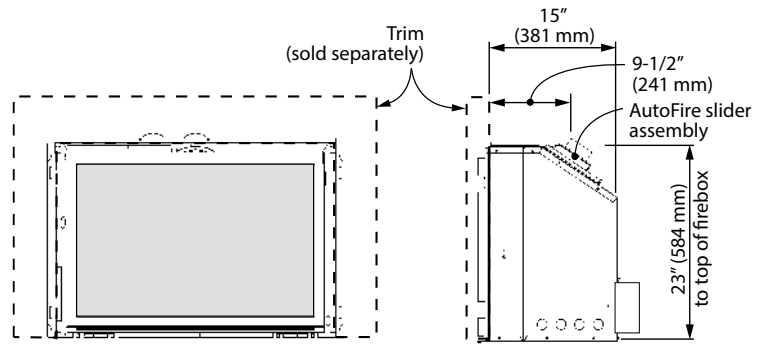
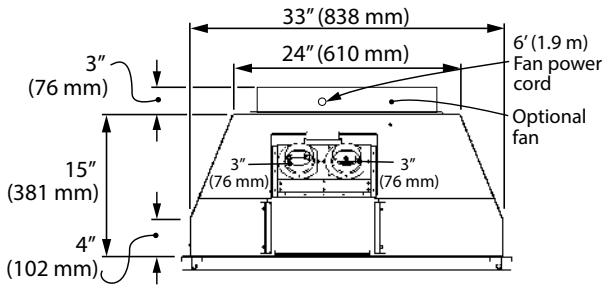

VENTING

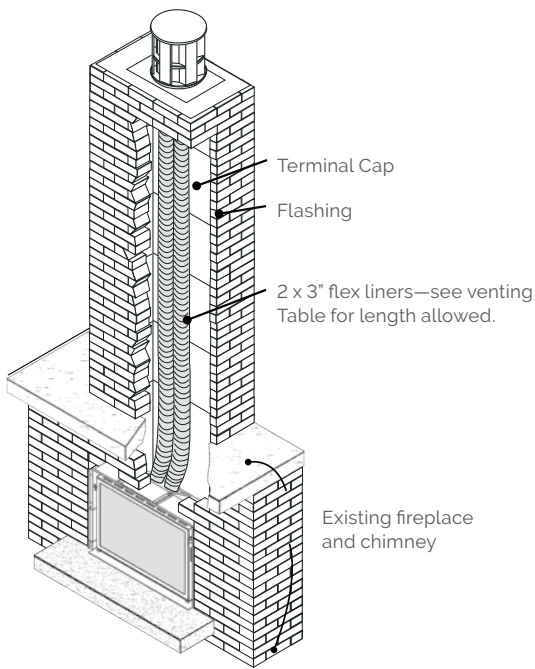

Note: The maximum vertical vent run for the Legend G4 is 40'. The minimum is 10'.

MANTEL CLEARANCES

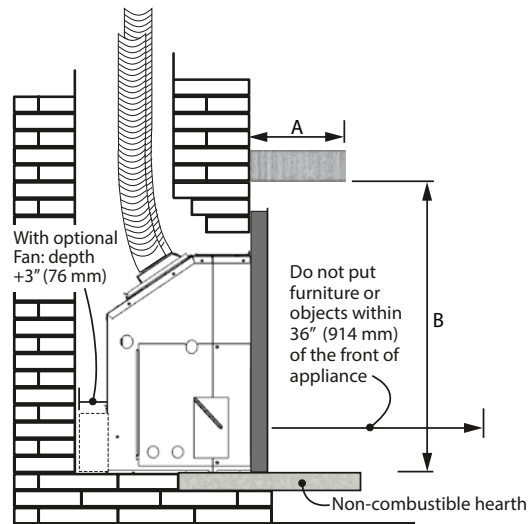

Mantel Projection A	1" (25 mm)	4" (101 mm)	8" (203 mm)	14" (355 mm)
Mantel Height B*	34" (864 mm)	36" (914 mm)	38" (965 mm)	40" (1016 mm)

*Measured from underside of mantel to finished hearth or surface that unit sits on.

NOTE: Edgemont trims, 799 and 784, require a larger and deeper cavity – see manual.

MINIMUM CAVITY DIMENSIONS

	All trims except Edgemont			With Edgemont trim	
	standard install	with leveling platform	with fan	no fan	with fan
Width*	33¼" (855 mm)	33¼" (855 mm)	33¼" (855 mm)	35¾" (908 mm)	
Depth X	15½" (394 mm)	16" (406 mm)	18½" (470 mm)	16¾" (426 mm)	19¾" (502 mm)
Height Y	23¼" (591 mm)	23¼" (591 mm)	23¼" (591 mm)	23¾" (603 mm)	

*minimum fireplace opening at front

**2½" Floating front
in Vintage Iron**

Rocks

Black Fluted liner



5" Floating front in Bronze

- Traditional Logs (deluxe)
- Ledgestone liner
- Black riser



SmartFire™

RADIANT HEAT

Like heat from the sun, **Valor®** fireplaces distribute radiant warmth directly to your living space. Radiant heat satisfies human comfort needs, using up to 25% less energy compared to traditional forced air systems. Valor warmth efficiently replaces the chill from cold windows and doors with steady, even heat to people and objects in the room.



PACIFIC NORTHWEST DESIGN, DEVELOPMENT & DISTRIBUTION

Locally owned and operated in the Pacific Northwest, every **Valor®** fireplace is designed, developed and manufactured exclusively for North America. With a proven product family history, Valor continues to introduce unique fireplaces that stand the test of time.

EASY CONTROL

Standard with every fireplace, our **ValorStat** remote gives you full control of your experience. Adjust the flame and heat to meet your desired comfort level as the room warms or as the outside temperature falls—truly a fireplace for all seasons.



THE COMFORT ZONE

Reduce your furnace's output of hot air into empty rooms and unused spaces. Zone heating requires no ducting or forced air, and delivers radiant and convective warmth to the spaces you frequent the most. Where you want it—when you want it.



BURN CLEAN, ENGINEERED GREEN

Valor® specializes in the design of clean heat solutions for your home.

Our fireplaces use natural gas, the cleanest fireplace fuel you can burn, with the lowest particulate levels and lowest levels of greenhouse gases on the market.



PRODUCT VERSATILITY

Valor® products are extremely diverse in their application and design. Whether new construction or home renovation, we offer a wide range of options to help you select the right fireplace for your personal heating needs.



SAVINGS

Valor® designs innovative fireplaces that include many cost-saving features: for example, pilot flame that automatically turns off if your fireplace is inactive for over five days, saving energy and lowering overall home heating costs.

Keep forgetting to turn down your fireplace? Set the **ValorStat** to automatically turn down after six hours.



NO POWER, NO PROBLEM.™

If the power fails in the winter, your home can get cold fast.

Valor® fireplaces are fully functional heaters that don't require electricity. Our fireplaces provide the perfect mixture of radiant and convective heat, eliminating the need for a fan. No power, no problem.



NO FAN NECESSARY

We firmly believe that you shouldn't have to put up with the constant buzz of a fan to be warm. That's why we designed glowing fires to radiate heat and secondary heat exchangers to naturally circulate warm air by convection throughout the room. While a fan is an option, you'll likely find it unnecessary.



RELIABILITY

With over 100 years in the heating industry, we take pride in providing high-quality, safe products.

Every **Valor®** product undergoes extensive safety testing so it's no surprise that many customers own more than one Valor fireplace in their lifetime.



FIREPLACE SAFETY — USE RADIANT HEAT SAFELY

Fireplace surfaces, in particular the glass viewing window, are extremely hot during operation and will remain hot for a period of time after the fireplace is turned off. Contact with the hot glass can cause severe burns. Close adult supervision is required if there are young children, or at-risk individuals in the house. Included with your purchase, a **Valor®** barrier screen is recommended at all times. Install an approved after-market safety gate to keep toddlers, young children and at-risk individuals a safe distance from the fireplace.

For more information please visit valorfireplaces.com/safety.

⚠ WARNING

This product can expose you to chemicals including Benzene, which is known to the State of California to cause cancer and birth defects or other reproductive harm.

For more information go to www.P65Warnings.ca.gov.

Proudly made in North America

Copyright Miles Industries Ltd. 2018
Designed and manufactured by
Miles Industries.





5" Floating front in Vintage Iron with Traditional Logs and Brick liner.

Your Authorized Valor Dealer

valor
THE ORIGINAL
RADIANT GAS FIREPLACE™

valorfireplaces.com