

Traditional Series

DIRECT VENT
GAS FIREPLACES



*Windom w/brick refractory
& brushed nickel accent grills*

Windom Specifications..... 2

936 Specifications 6

SP36 Specifications 4

Fireplace Options
& Accessories..... 8

MODELS
WINDOM • SP36 • 936

Windom Rear Direct Vent Gas Specifications



Windom w/brick refractory

Model	Fuel Opt.	High	Low	Max. Efficiency
#56101	NG	23,000	16,000	80%
	LP	19,000	14,000	82%

Features

- Canada P-4 approved
- One of the slimmest fireplace depths in the industry – only 11”!
- Rear vent for easy installation
- High quality lifetime warranty glass (17” x 30”)
- Quick-latch glass with standard arched valance
- High-low regulator
- Zero clearance
- Patented burner employs groundbreaking vertical flame technology
- Tested to 50 pascals of negative pressure which passes the Minnesota Energy Code for Residential Ventilation

Safety

- Each unit factory tested!
- Tested by OMNI-Test Laboratories
- Complies with ANSI Z21.88-2009 • CSA 2.33-2009 ‘Vented Gas Fireplace Heater’
- Sealed combustion chamber
- Removable millivolt board with 30-second delay
- Safety pilot with piezo standing pilot ignition
- Requires **no electricity** to operate - excluding fan
- Automatic pressure relief glass system
- Bedroom and mobile home approved

Vent System and Requirements

- Minimum vertical vent run - 0”
- Maximum vertical run - 25’
- Minimum horizontal run - 6”
- Maximum horizontal run - 14’

Specifications

Height	32”
Height at back	30 1/8”
Front width	36”
Back width	23 3/8”
Depth	11”
Flue size	4” exhaust 6 5/8” combustion air

Framing Dimensions

Height	32 1/4”
Width	36 1/2”
Depth	11 1/4”
Platform	36” W x 11” D
Firestop framing - refer to vent manufacturer's specifications	

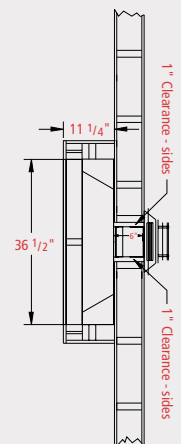
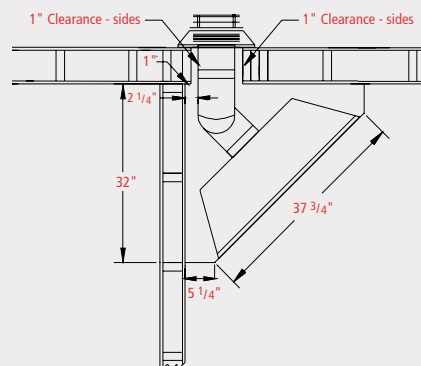
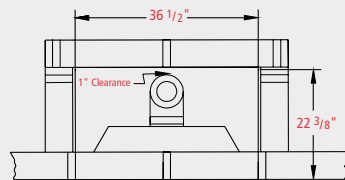
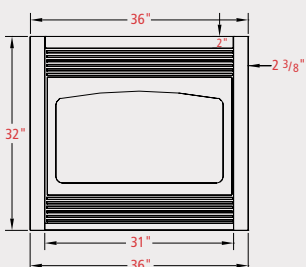



*Windom w/Brushed nickel Prairie design doors -
black Prairie design grills - Aspen corner cabinet
w/topper - Ubatuba Granite*

Small space, big warmth...

Warm up even the smallest space with Kozy Heat's "Windom" rear-direct vent gas fireplace. With a depth of only 11", it's the slimmest fireplace in the industry! It's slim depth is one of the "Windom's" biggest benefits, not to mention an incredible burn. Choose from a variety of optional accessories to complement your home's décor.

SP36 Direct Vent Gas Specifications



SP36 w/black screen doors & brick refractory

Model	Fuel Opt.	High	Low	Max. Efficiency
#SP 36	NG	32,000	26,000	81%
#SP 36-1	LP	30,000	21,000	83%

Features

- 32,000 BTU/hr Input-NG & 30,000 BTU/hr Input - LP
- High quality lifetime warranty glass (17" x 30")
- Quicklatch glass assembly
- Rectangular valance
- High-low regulator
- Zero clearance
- Patented burner & log design
- Tested to 50 pascals of negative pressure which passes the Minnesota Energy Code for Residential Ventilation

Safety

- **Each unit factory tested!**
- Tested by OMNI-Test Laboratories
- Complies with ANSI Z21.88b-2008 • CSA 2.33b-2008 'Vented Gas Fireplace Heater'
- Sealed combustion chamber
- Removable millivolt board with 30-second delay
- Safety pilot with piezo standing pilot ignition
- Requires **no electricity** to operate - excluding fan
- Automatic pressure relief glass system
- Bedroom and mobile home approved

Venting Systems & Requirements

4" Exhaust 7" Intake

- #745 direct vent kit - 4' termination
- #718 direct vent kit - 8' termination
- #746 direct vent extension kit - 6' additional pipe to extend the #745 or #718 vent kits

Horizontal Terminations

Horizontal termination - min. 1/4" rise per ft. of run

Flex pipe -

Min. vertical rise** - 18" (determined by horizontal run)

Min. horizontal run - 6"

Max. horizontal run - 20' (requires 50" vertical rise)

Elbows - (1) 90° (or equivalent thereof)

NOTE: For each additional elbow used after the 1st elbow, you must subtract 5' from the max. horizontal run allowed

Dura-Vent™ DV-GS or AmeriVent Pipe - 4"x 6-5/8"

#923-C adapter, followed by 90° elbow, then a min/max horizontal vent run of 6". NOTE: This is the only accepted configuration that can be used without a snorkel kit.

Dura-Vent™ DV-GS only - #923-C adapter, followed by a 90° elbow, then a min. horizontal run of 6" NOTE: A snorkel kit must then be used on the outside of the house if the horizontal run is greater than 6" (max. is 2' 6") to ensure proper draft and compliance to the venting requirements as tested.

NOTE: For vent runs greater than 2' 6", see the Horizontal/Vertical Venting chart in your install manual for vertical min.

Vertical Terminations

Min. vertical rise** - 18" (determined by horizontal run)

Max. vertical run from top of unit - 32'

Dura-Vent™ DV-GS or AmeriVent™ pipe termination - 4"x 6-5/8"

- Adaptor #923-C must be used with Dura Vent™/AmeriVent™
- Elbows - maximum - (2) 45°

*Total horizontal & vertical run must not exceed 32'.

** Minimum vertical rise is to the top of the pipe.

Specifications		Framing Dimensions	
Height	32"	Height	32 1/4"
Width	36"	Width	36 1/2"
Back width	27 7/8"	Depth	15 1/4"
Depth	15"	Platform	36" W x 15" D
Weight	135 lbs		

Clearances

From unit sides/back/top stand-offs	0"
To flooring	0"
From flue vent	1"
From unit glass to an adjacent sidewall	8"
From upper grill outlet to a 7" mantel	12"

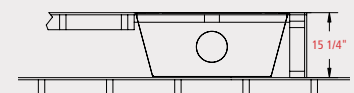
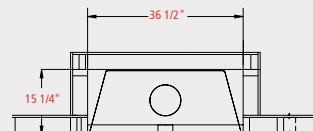
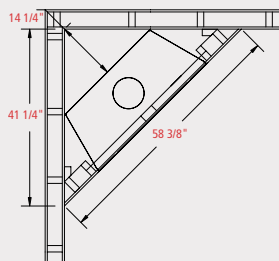
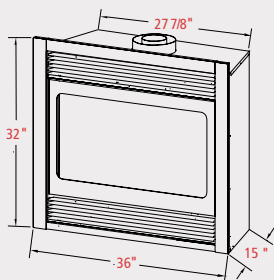



SP36 w/brick refractory

Warmth where you need it...

The slim profile of Kozy Heat's model SP36 offers you the opportunity to install ambiance in virtually any room of your home. Not only is the SP36 easy to install, it also uses very little floor space. You'll appreciate the price and ease of installation, while your family and friends will enjoy the added heat and large open view of a beautiful gas burning fire.

936 Direct Vent Gas Specifications



#936 w/Prairie design doors
& Mission design grills

Model	Fuel Opt	High	Low	Max. Efficiency
#936	NG	36,000	23,000	81%
#936-1	LP	35,000	23,000	80%

Features

- High quality lifetime warranty glass (17" x 30")
- Quick-latch glass with standard arched valance
- Seasonal heat-dump baffle
- Refractory firebrick panels (back and sides)
- High-low regulator
- Zero clearance
- Patented burner and log design
- Tested to 50 pascals of negative pressure which passes the Minnesota Energy Code for Residential Ventilation

Safety

- **Each unit factory tested!**
- Tested by Intertek Testing Services (formerly Warnock Hersey) complies with ANSI Z21.88 - 2002 • CSA 2.33 - M02 'Vented Gas Fireplace Heater'
- Sealed combustion chamber
- Removable millivolt board with 30-second delay
- Requires **no electricity** to operate - excluding fan
- Automatic pressure relief glass system
- Bedroom and mobile home approved

Venting Systems & Requirements

- #745 direct vent kit - 4' termination
- #718 direct vent kit - 8' termination
4" exhaust, 7" intake co-axial
- #746 direct vent extension kit -
6' additional pipe to extend the #745 or #718 vent kits

Horizontal Terminations

- Minimum vertical rise - 18" (determined by horizontal run)
- Minimum horizontal run - 6"
- Maximum horizontal run - 20"
- Elbows - (1) 90° (or equivalent thereof)
*1/4" incline per horizontal foot must be maintained

Vertical Terminations

- Minimum vertical rise - 18" (determined by horizontal run)
- Maximum vertical run from top of unit - 32'
- Dura-Vent™ DV-GS pipe termination - 4" x 6 5/8" (vertical only)
- Adapter #923-C must be used with Dura Vent GS pipe™
- Elbows - maximum - (2) 45°

Framing Dimensions

Height	32 1/4"
Width	36 1/2"
Depth	18 1/2"
Platform	36" W x 18 1/4" D
Firestop framing	9 1/2" x 9 1/2"

Clearances

From unit sides/back/top stand-offs	0"
To flooring	0"
From flue vent	1"
From unit glass to an adjacent sidewall	8"
From upper grill outlet mantel	Refer to install. manual

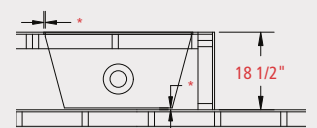
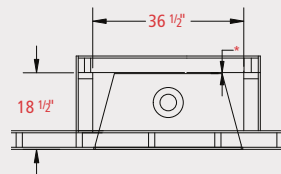
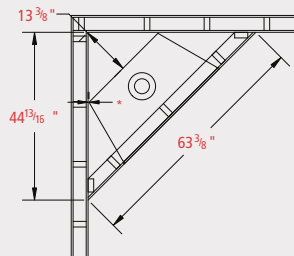
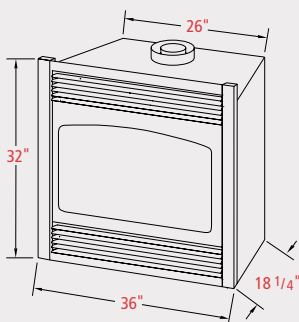



#936 w/brass accent grills

**It's just not "home"
without a fireplace...**

Think your room is too small for a fireplace? Think again. With Kozy Heat model 936 direct vent you'll get a clean, efficient, gas fireplace with all the ambiance of a real wood-burning fire. With a variety of accessories and options, there's a Kozy Heat fireplace that's right for you.

Fireplace Options & Accessories

Optional Features	WDM	#SP36	#936
Dura-Vent/AmeriVent adaptor ring for DV-GS pipe		X	X
Decorative grills	X	X	X
Arched valance (replaces the retang. valance)		X	
Arched valance brass and/or chrome glass trim	X	X	X
Black, brass and/or chrome "T" Trim	X	X	X
Interior or exterior black trim (finish around edges)	X	X	X
Decorative screen doors	X	X	X
Rectangular valance (replaces arched valance)	X		X
Valance screen	X	X	X
Automatic fan kit w/variable speed control (2-75 CFM)	X		
Automatic fan kit w/variable speed control (2-110 CFM)		X	X
Remote control/thermostat remote	X	X	X
Wall mount thermostat/wireless wall mount	X	X	X
Decorative beveled oval design or paneled glass	X	X	X
Brick refractory	X	X	
Rock refractory			X
Enamel Panels	X		
Wall, corner cabinet & flush surround (Refer to the cabinetry brochure)	X	X	X

Doors



Black Prairie screen door

Black screen door

The above doors are available in all finishes, only black contains screen

Finishes



Onyx

Antique Copper

Brushed Nickel

Controls



Wall mount thermostat

Wireless wall mount thermostat

Wireless wall switch

Remote control

Trims



Arched valance brass trim

Arched valance chrome trim

Rectangular valance

Valance screen

Grill Sets

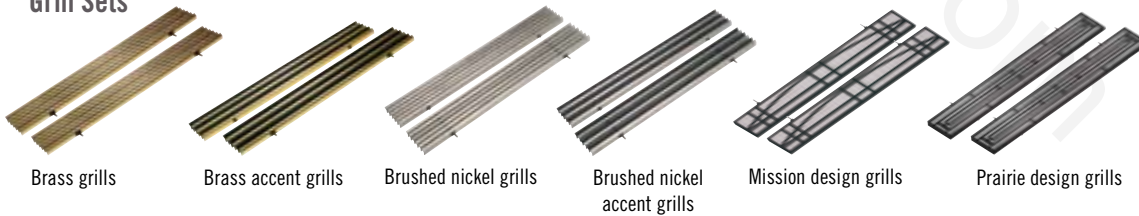

Brass grills

Brass accent grills

Brushed nickel grills

Brushed nickel accent grills

Mission design grills

Prairie design grills

Black, chrome and chrome accent grills not shown

Refractory



Brick refractory



Rock refractory



Black enamel panels

Kozy Heat Product Line



Woodburning Fireplaces

Classic DV Gas Fireplaces

Traditional DV Gas Fireplaces

Contemporary Gas Fireplaces

Gas Inserts

Free-Standing Gas Stove

Handcrafted Cabinetry

In order to continually provide the highest quality product available, features/options, specifications & dimensions are subject to change. Refer to the unit installation manual for complete installation instructions. Installation must conform with local building codes. **In some regions it may be possible that this appliance qualifies for an energy rebate. See your local dealer for details regarding promotions and qualifications.**

Manufactured by Hussong Mfg. Co. Inc.
204 Industrial Park Drive, Lakefield, MN 56150
Phone 1-800-253-4904 www.kozyheat.com

5-12



For complete information on the Kozy Heat product line, please contact us at: